



# Obnovljivi viri energije

Franc Beravs

A stylized smiley face graphic composed of three horizontal grey bars. The top and bottom bars have rounded ends, while the middle bar is a simple rectangle. The text "Pogled nazaj" is centered within the middle bar.

Pogled nazaj

# Začelo se je s tem:

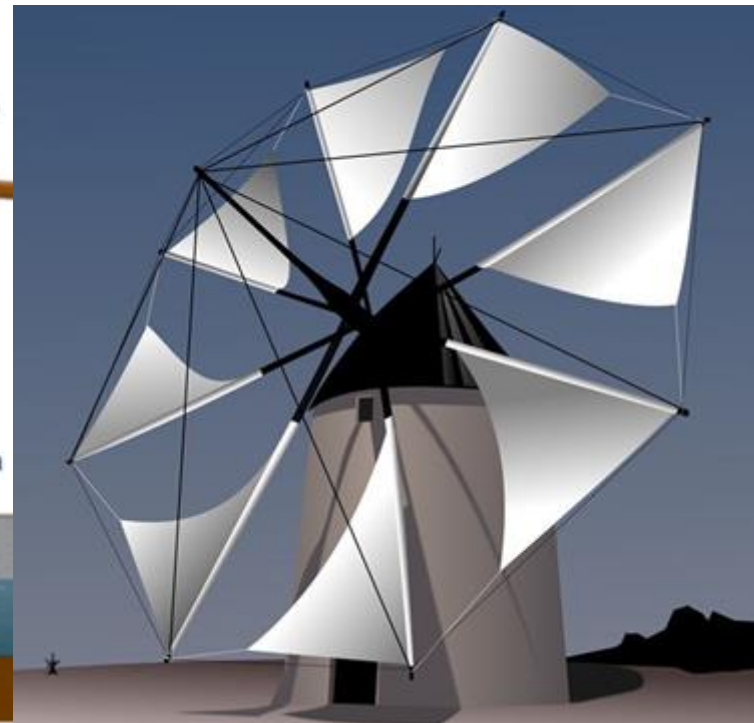
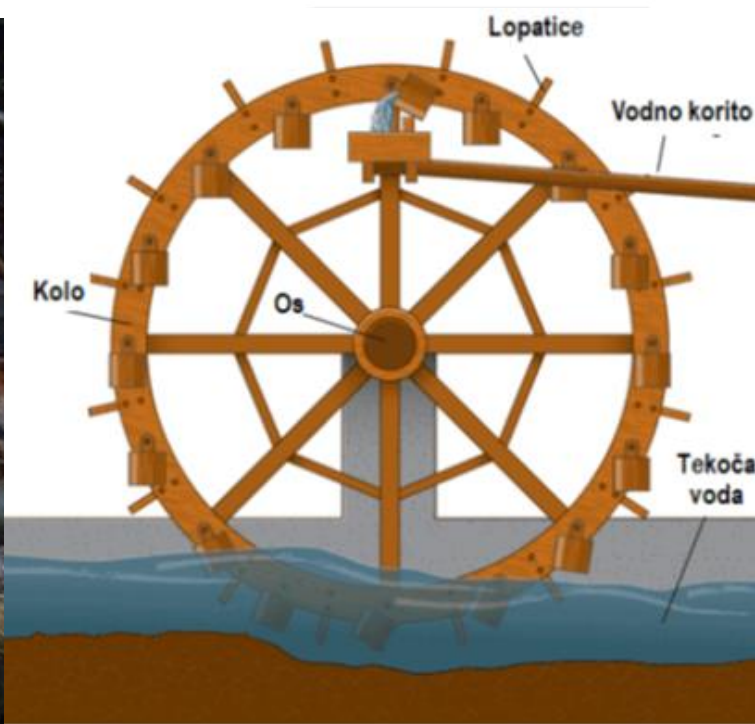

# Tehnološki razvoj in raba energije

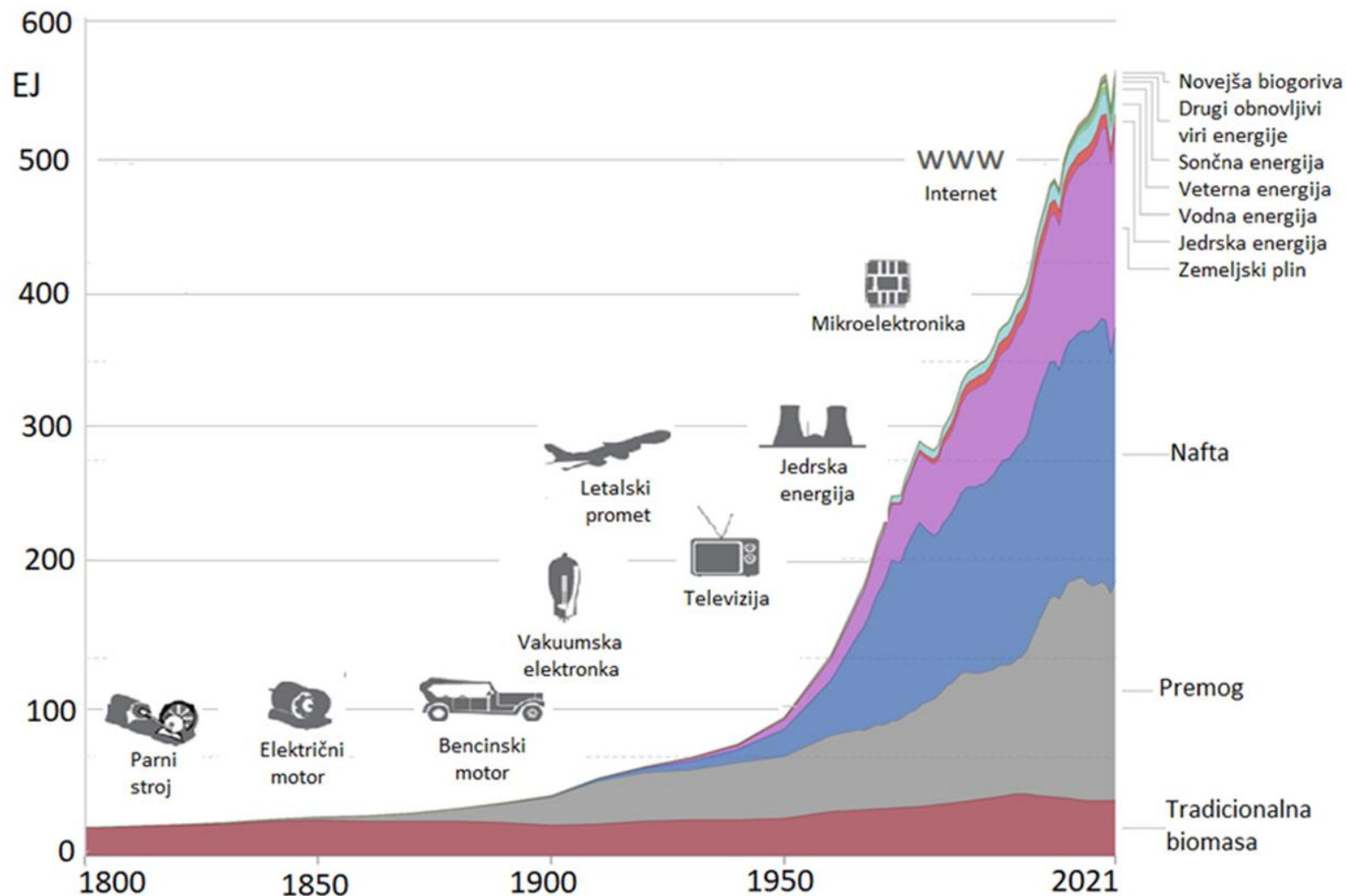

# Tehnološki razvoj in svetovna letna raba energije na prebivalca

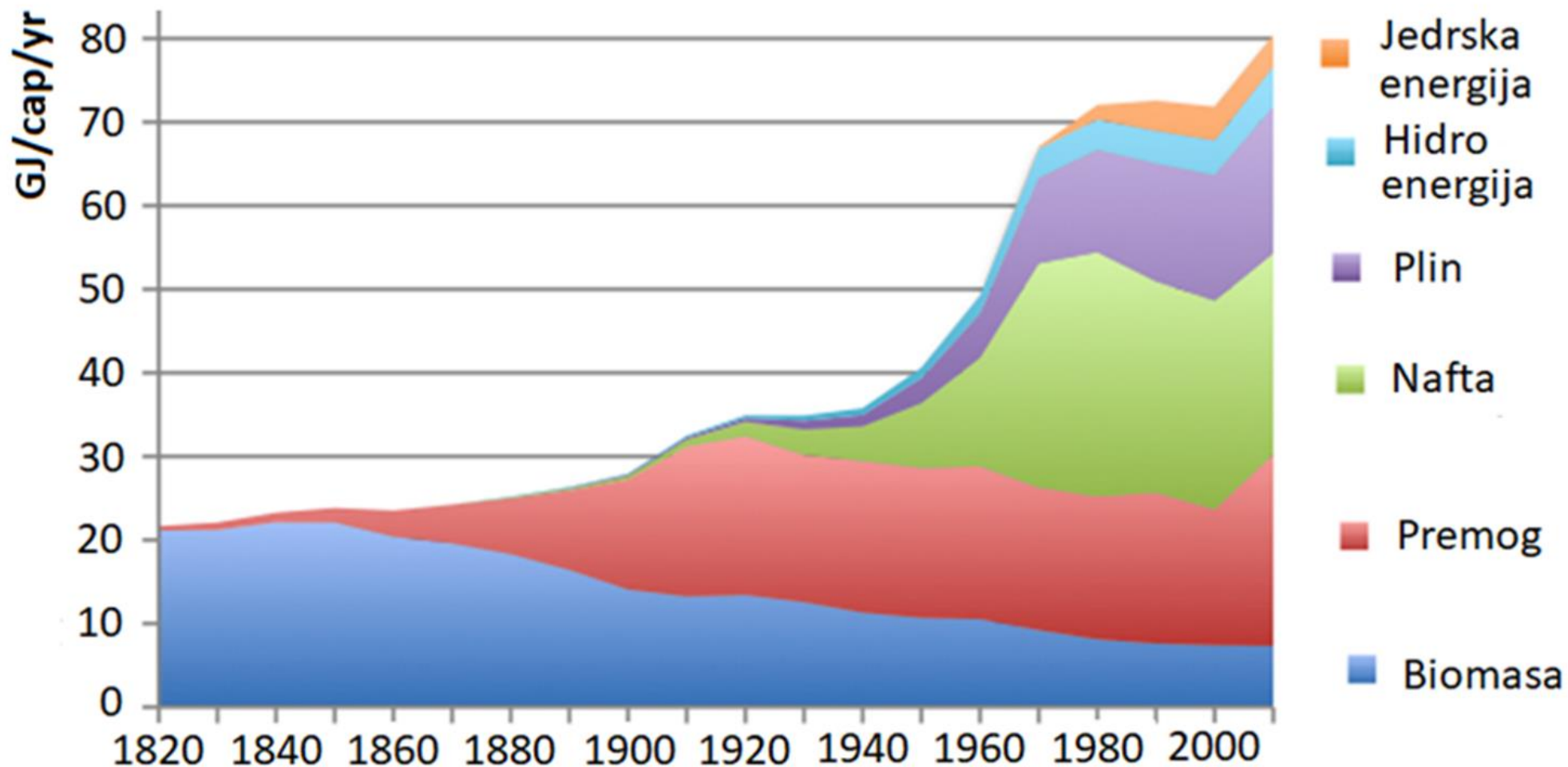

# Neučinkovitost izrabe primarnih energijskih virov

## Energijski sistem

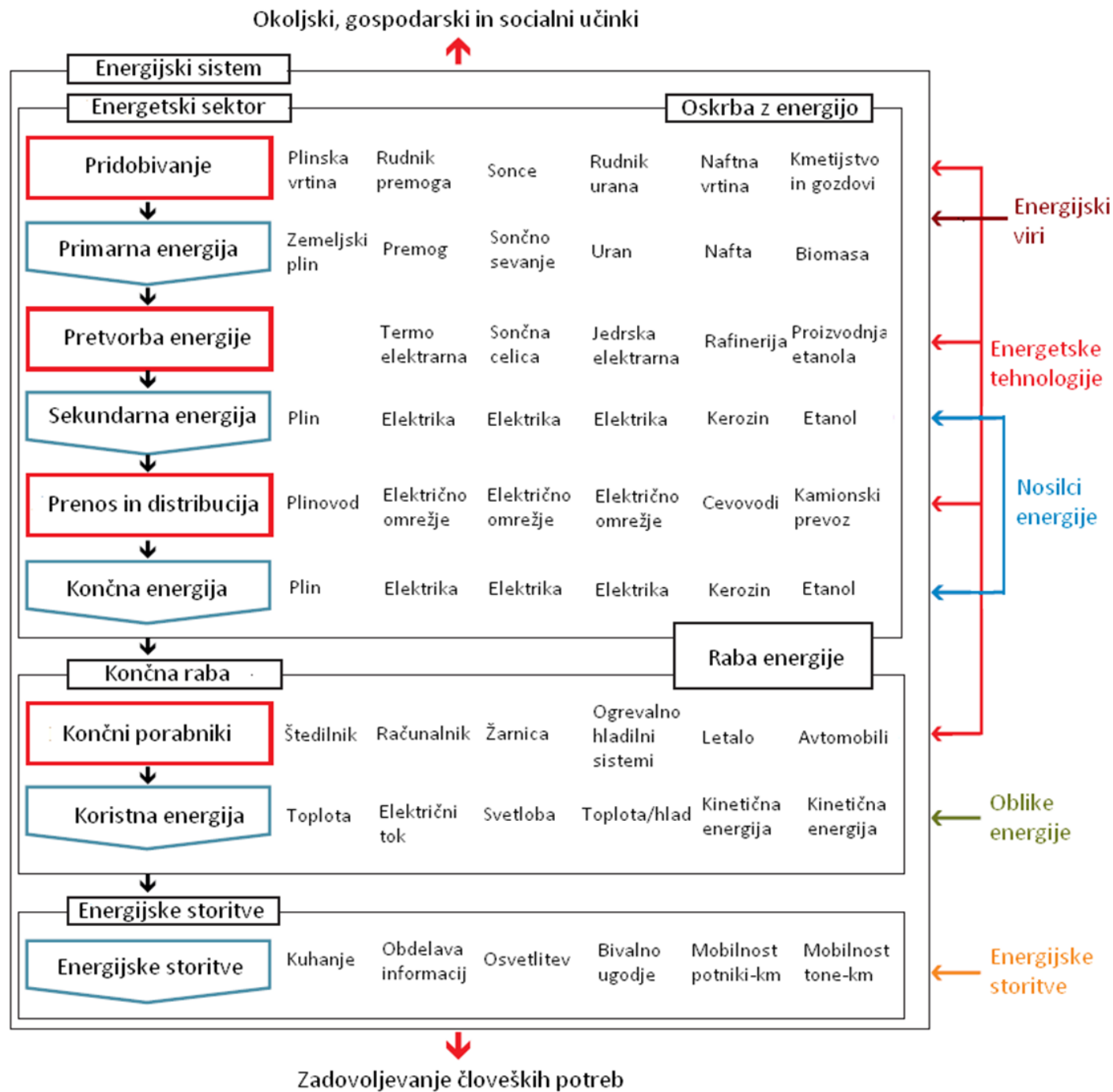

# Izkoristek različnih primarnih energijskih virov do energijske storitve

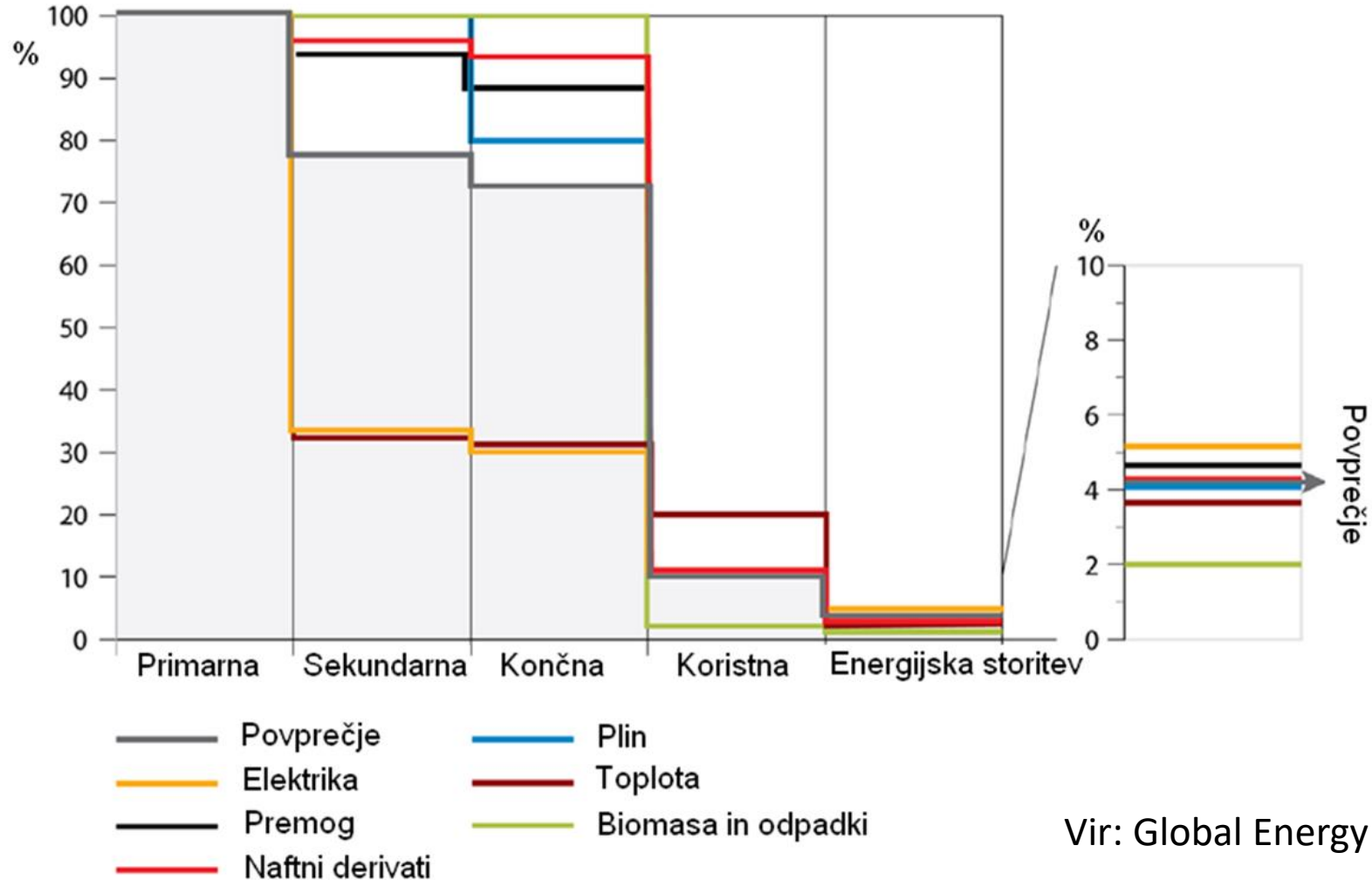

Vir: Global Energy Assessment 2012





# Oskrba z energijo v svetu in doma

# Globalna raba primarne energije

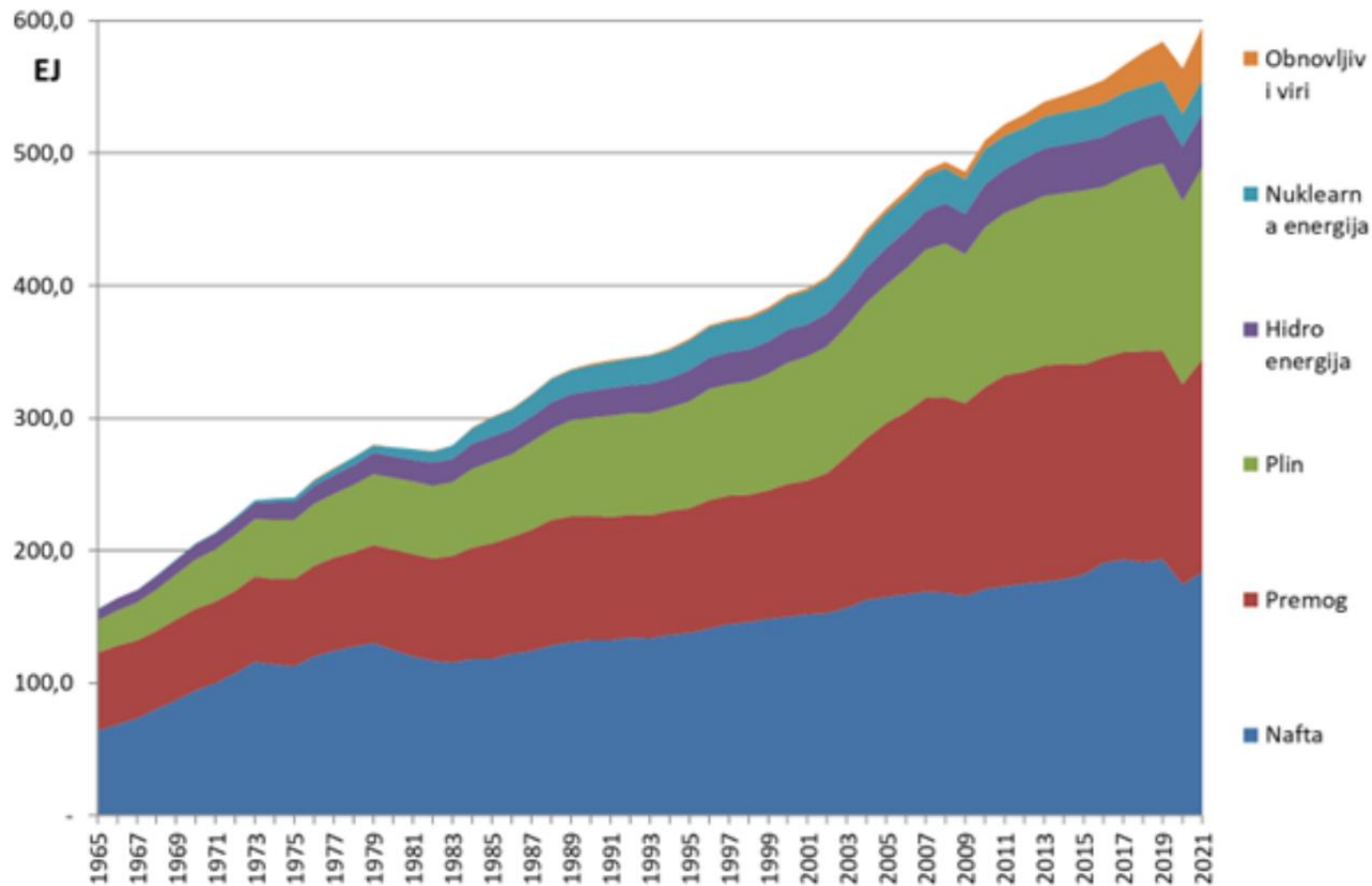

# Struktura globalne rabe primarne energije

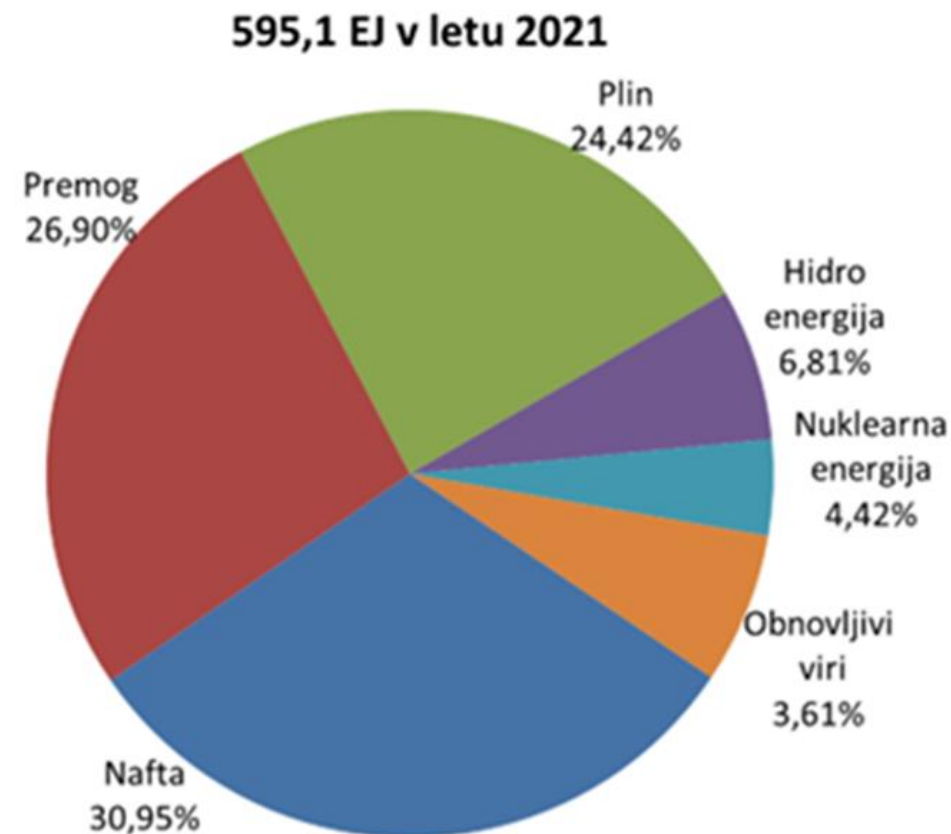
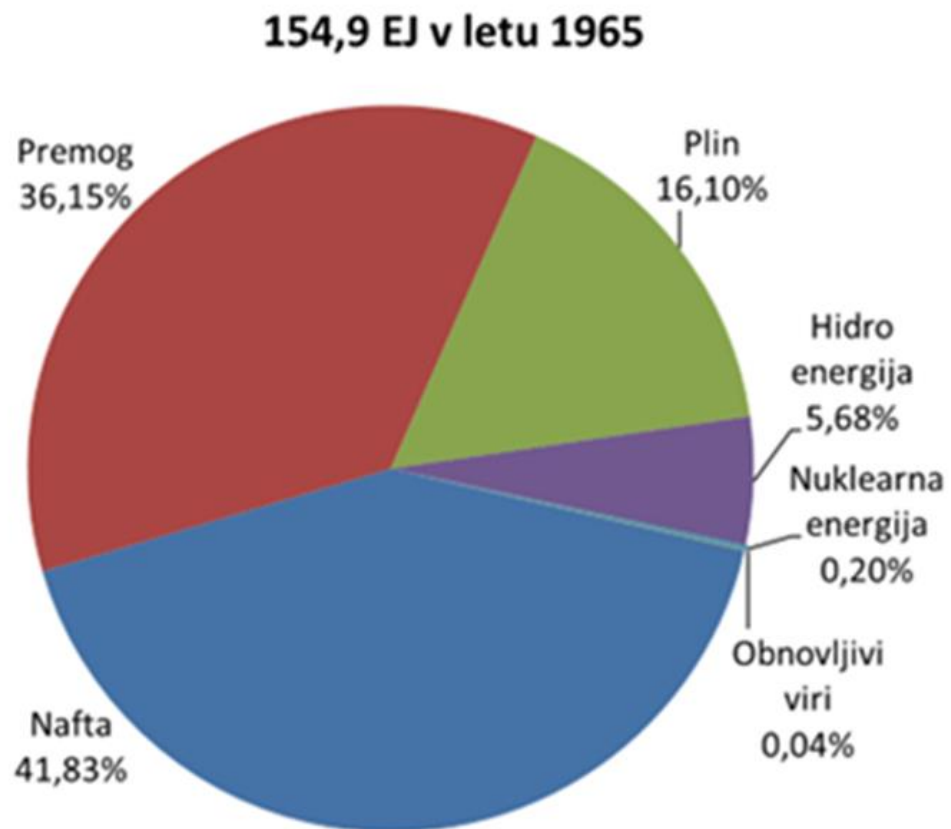

# Globalna raba primarne energije po področjih

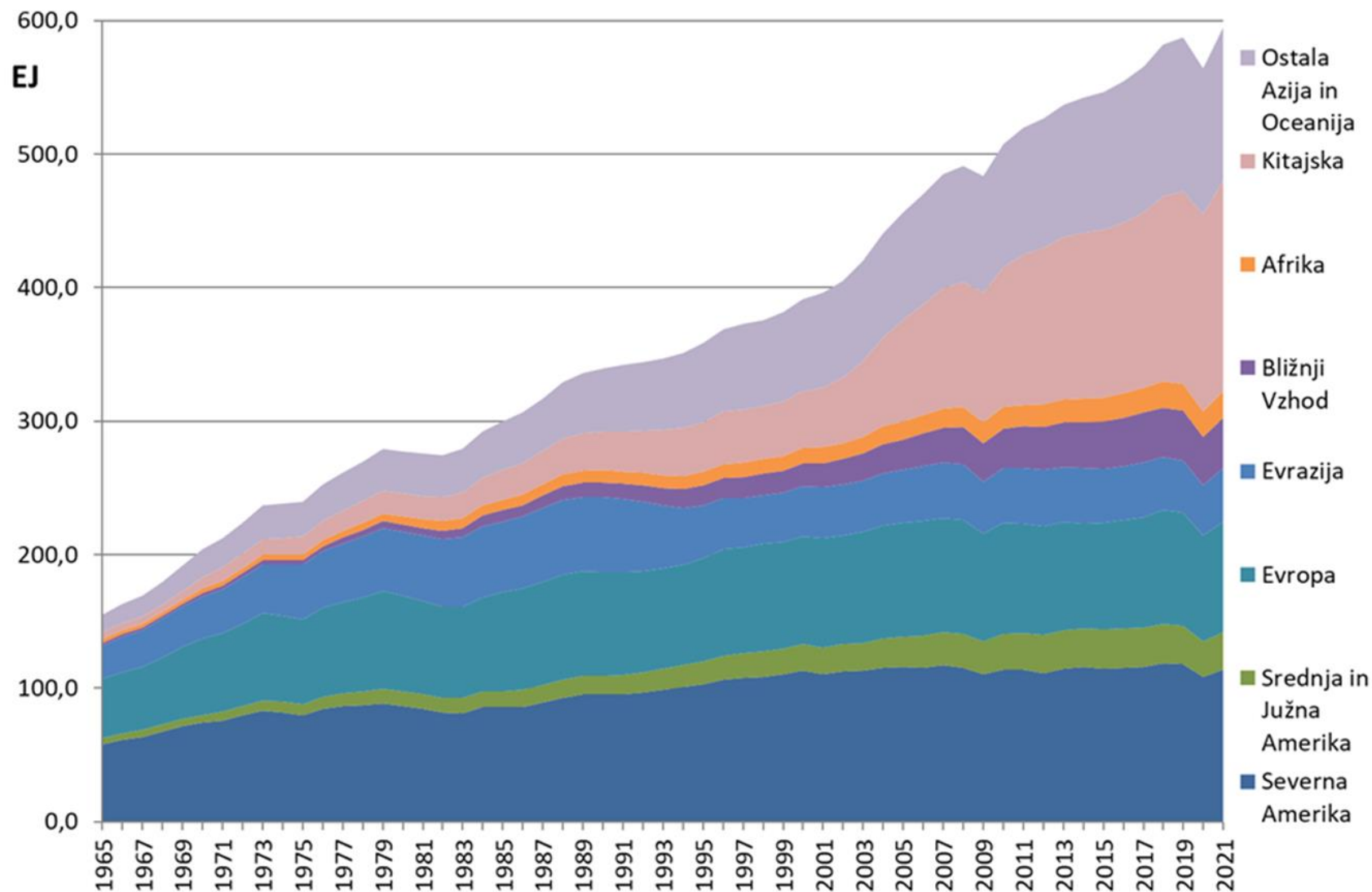

# Struktura globalne rabe primarne energije po področjih

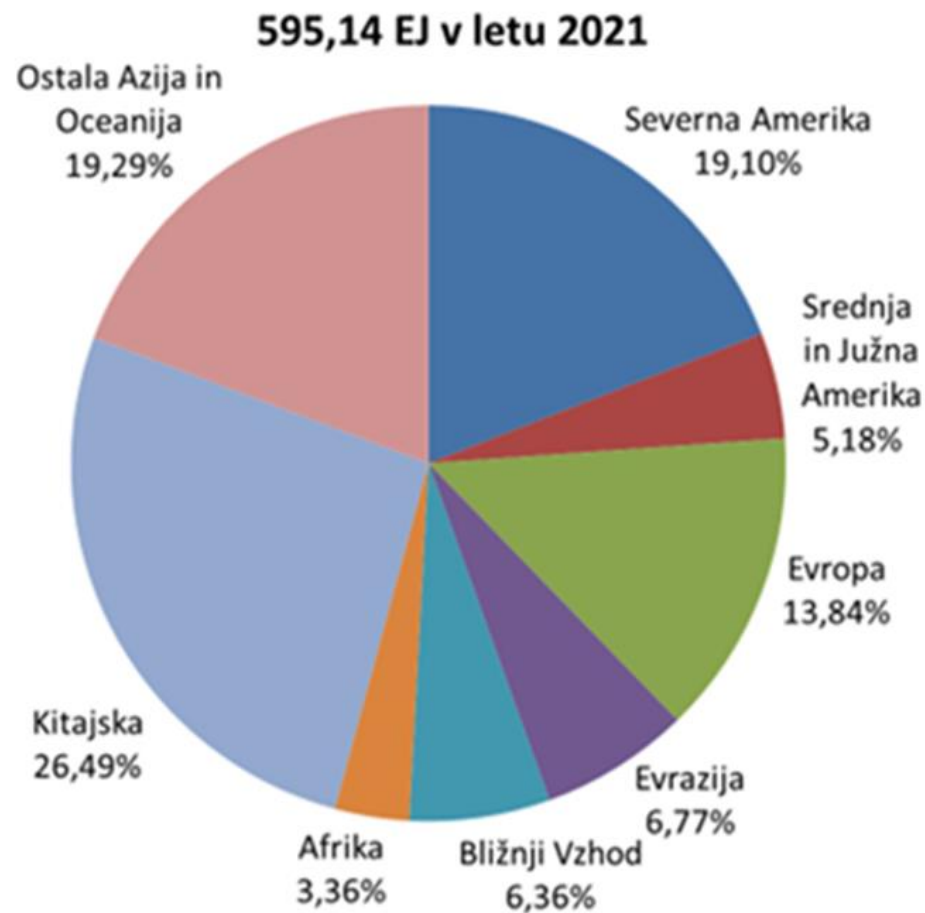
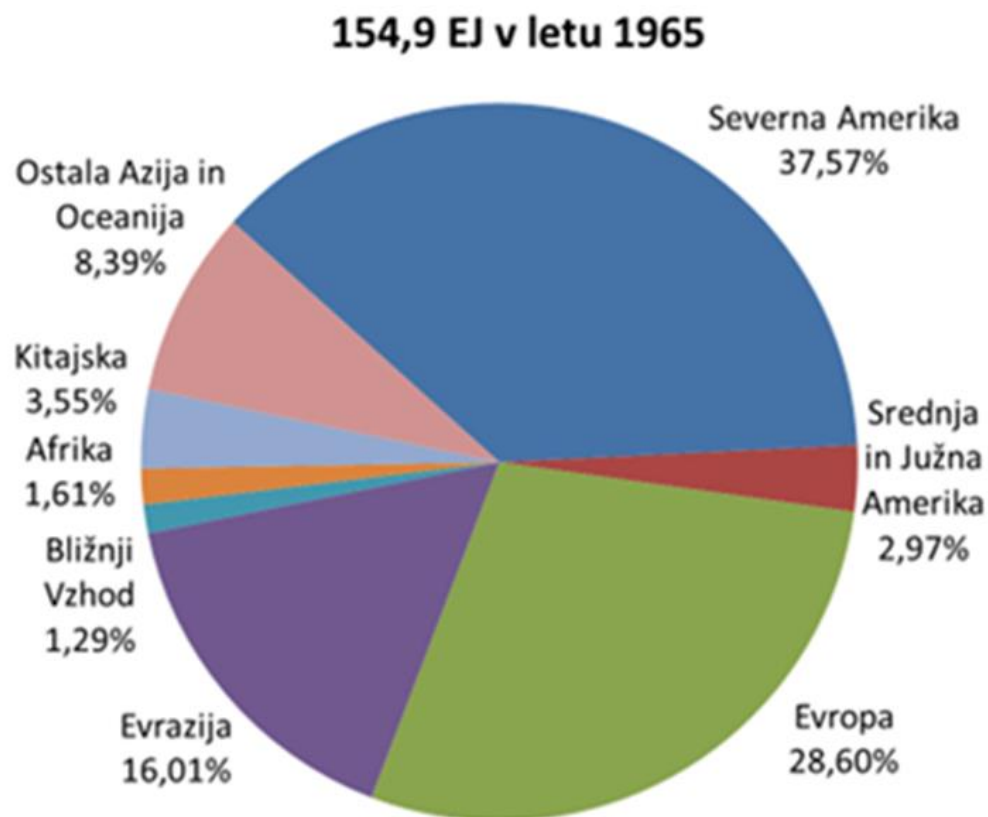

# Oskrba z energijo (primarna raba) v Sloveniji

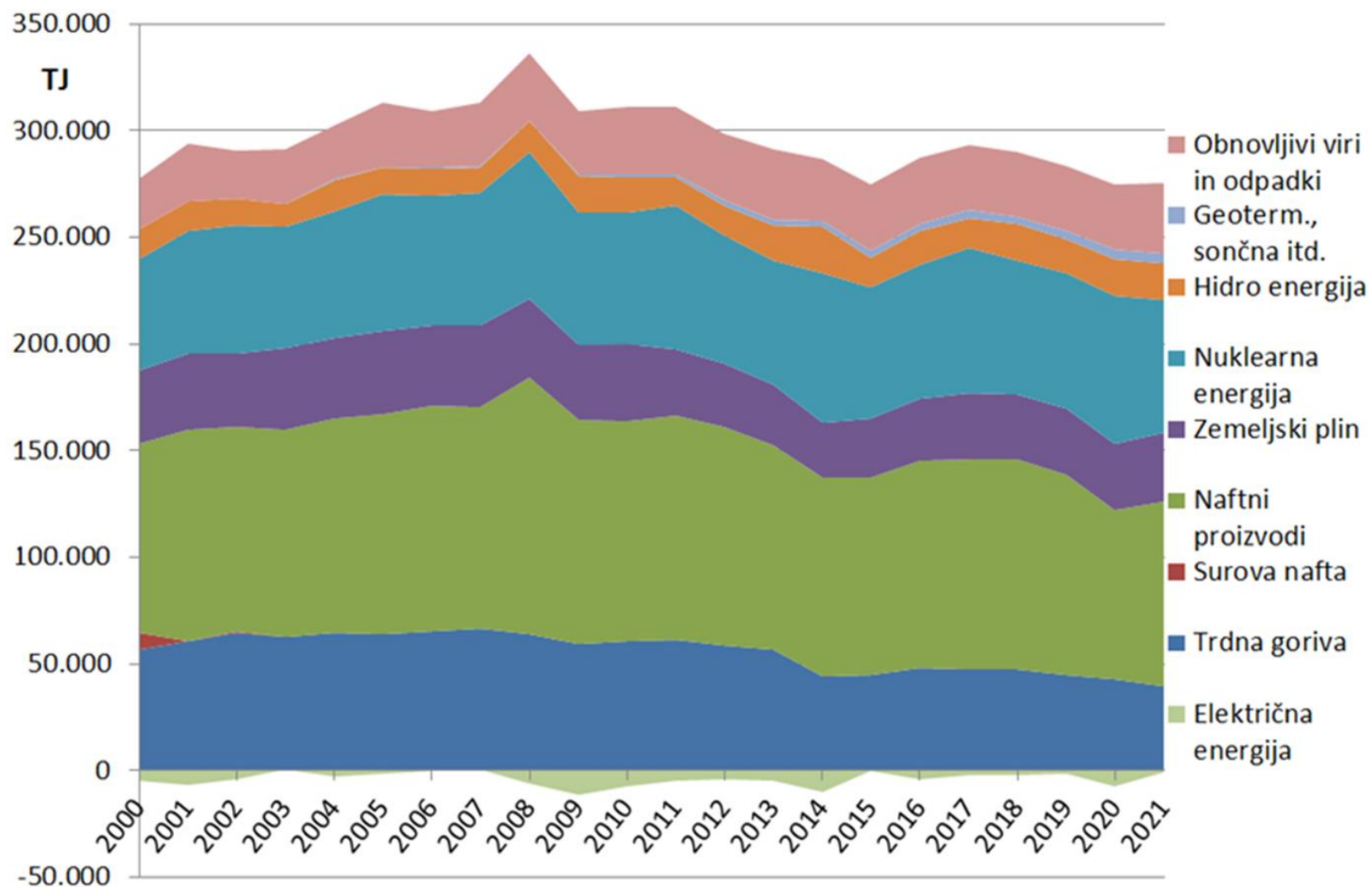

# Struktura primarne rabe energije v Sloveniji

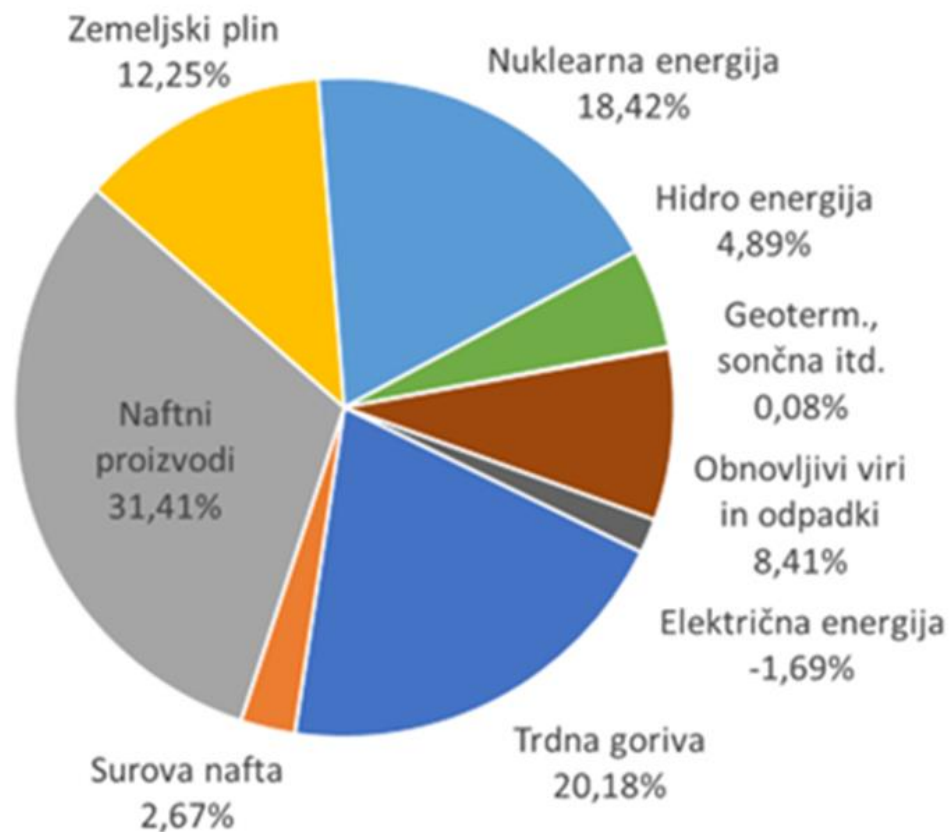
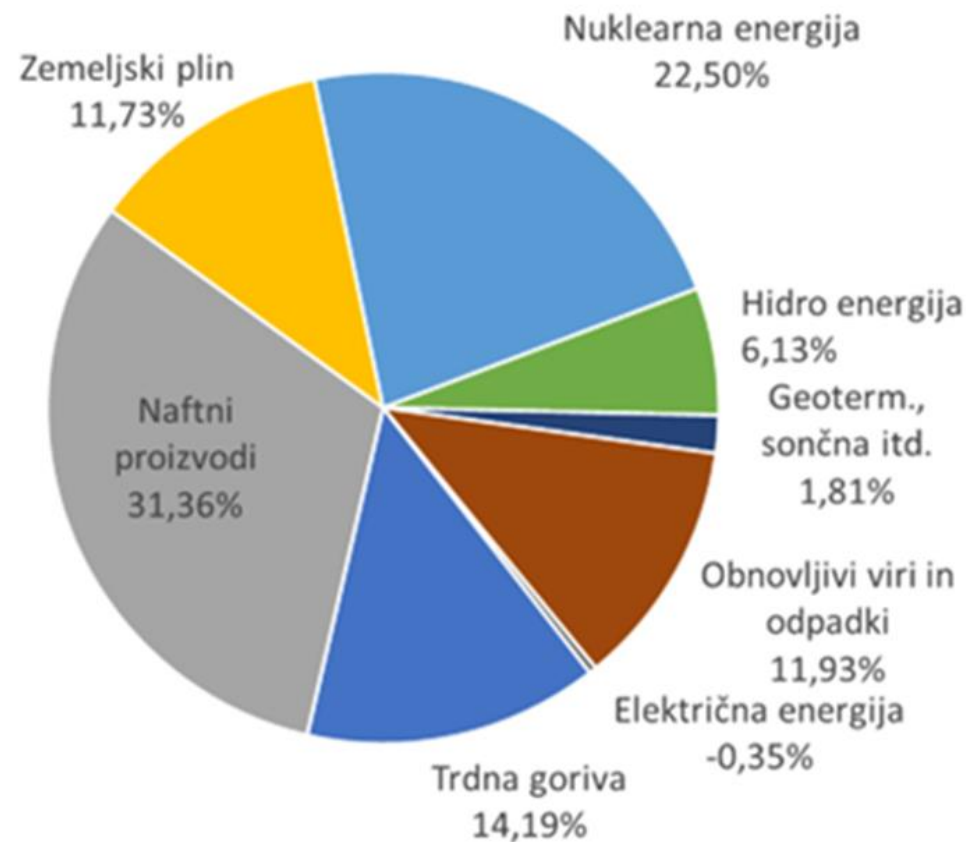
**272,5 Pj v letu 2000****274,7 PJ v letu 2021**

# Poraba primarne energije na prebivalca v EU v letu 2021

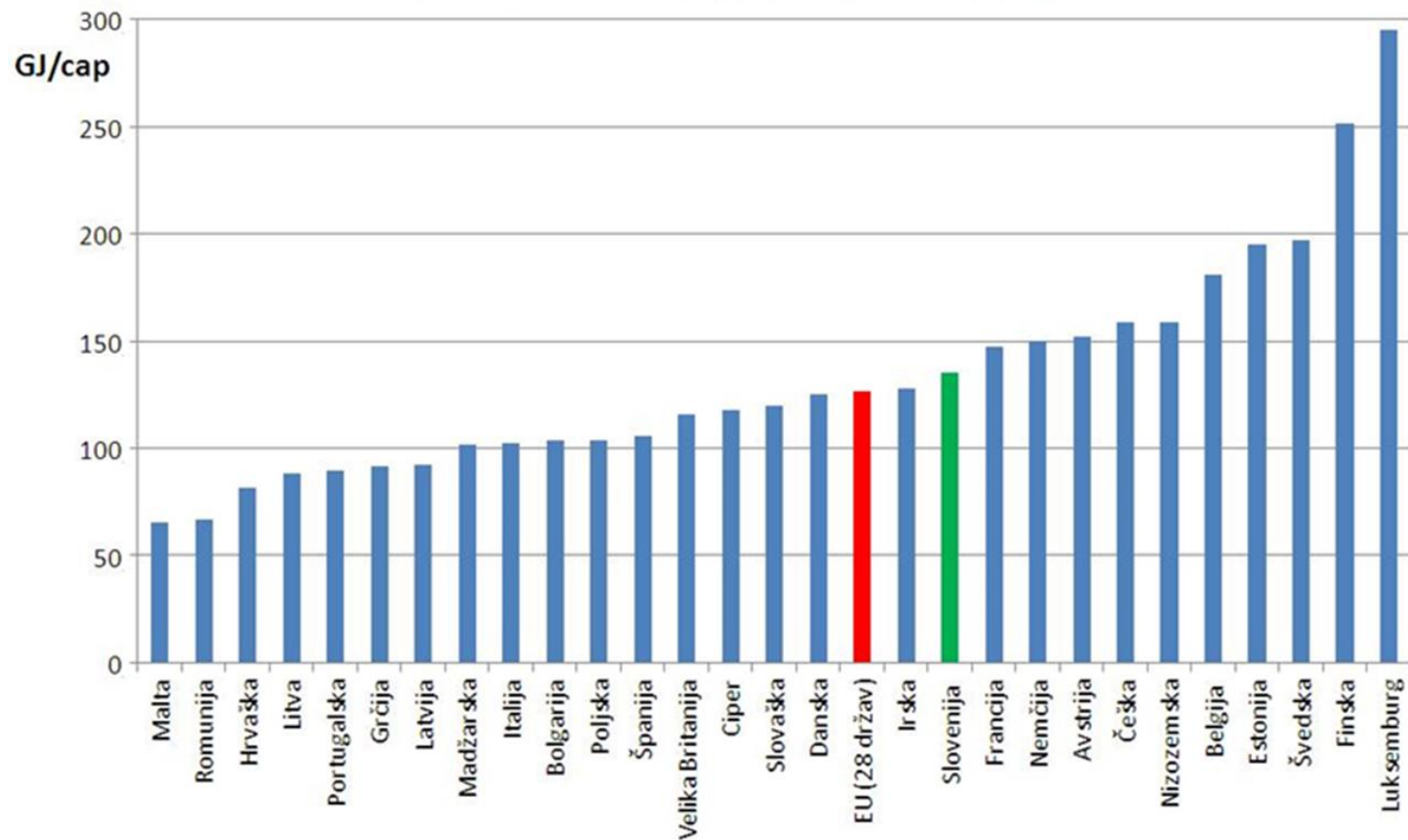



# Končna raba energije v Sloveniji

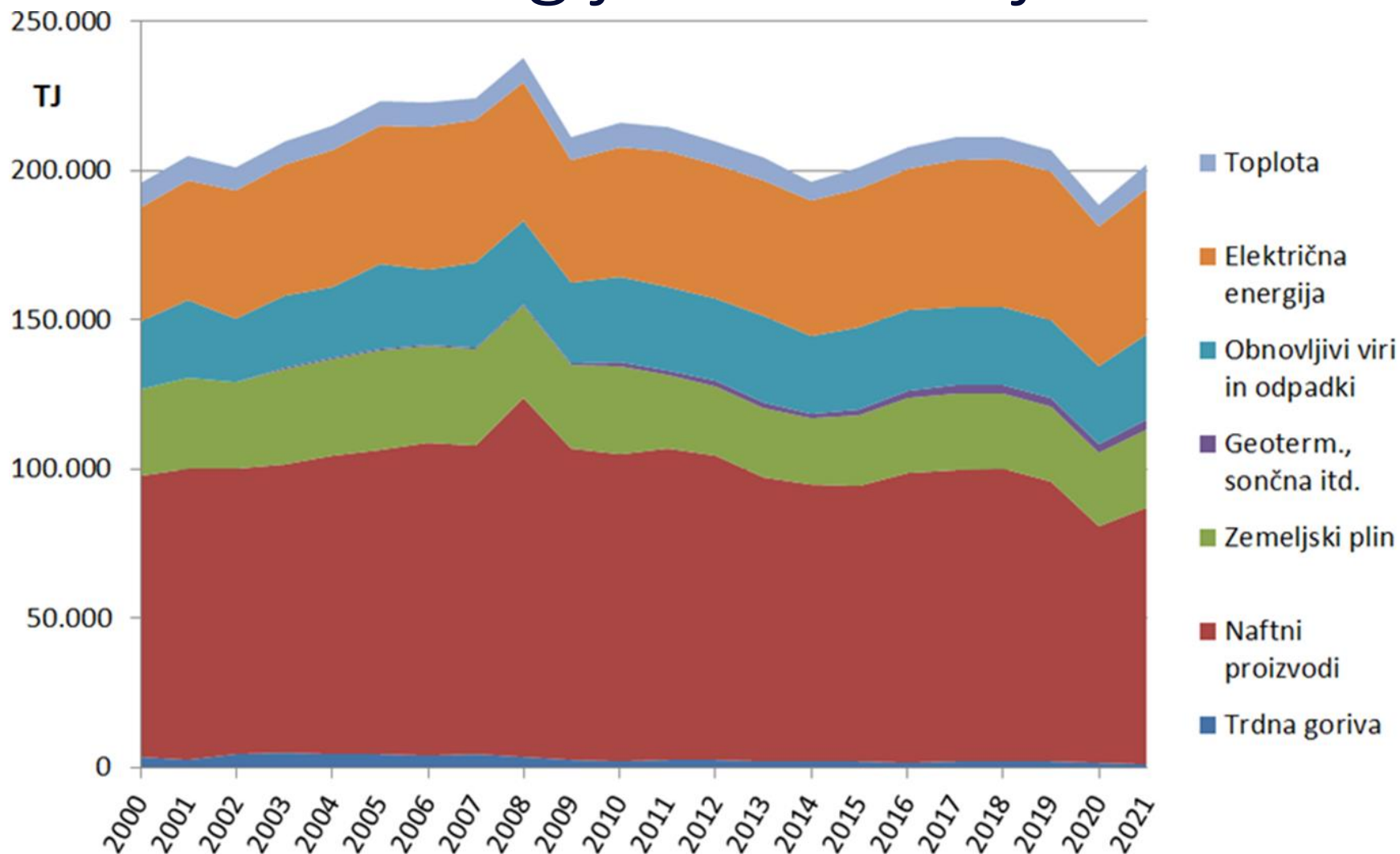

# Delež OVE v bruto končni rabi energije

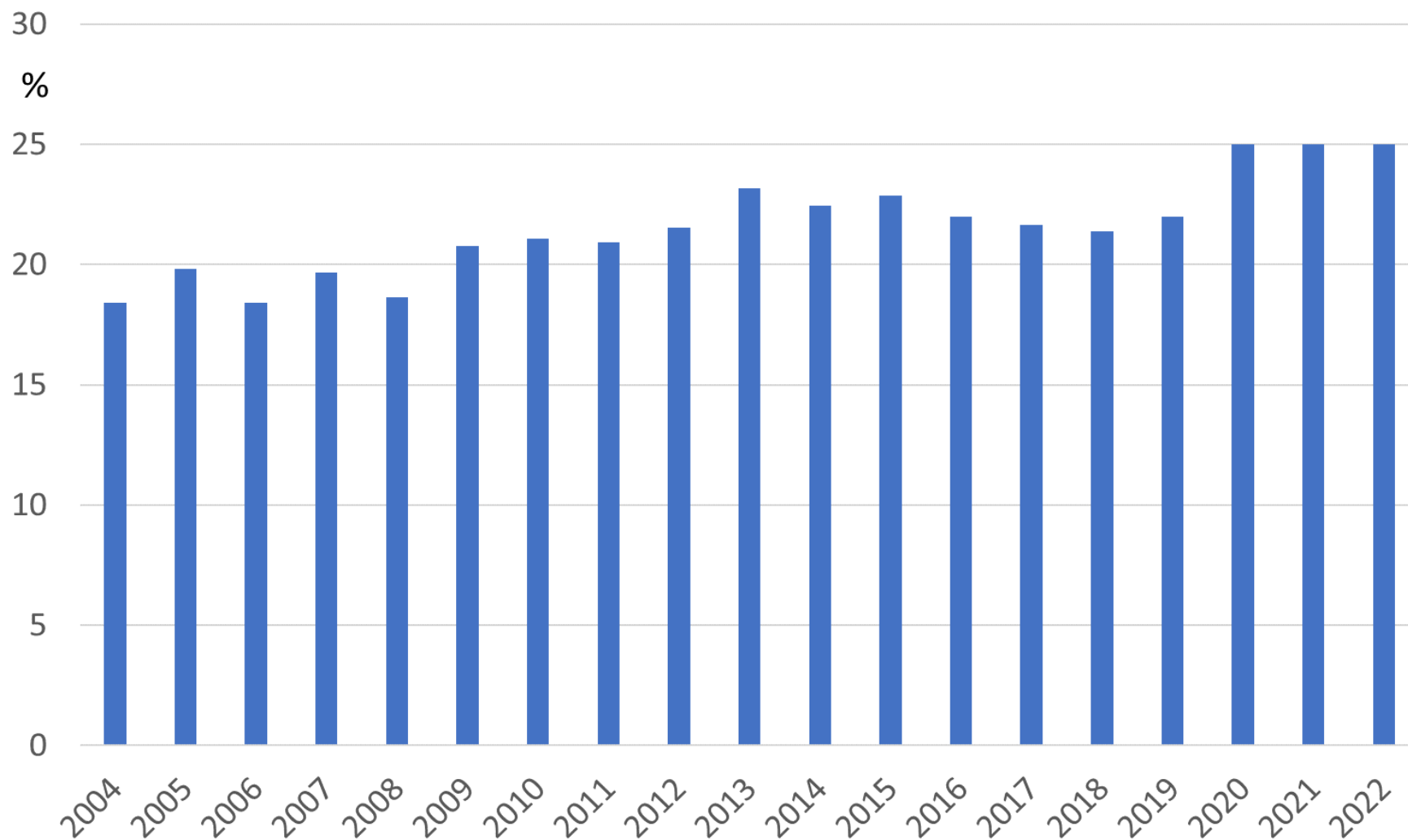



# Pogled naprej

# Resolucija o Dolgoročni podnebni strategiji Slovenije do leta 2050 (Sprejeta 13. julija 2021 v DZ)

Slovenija si z Resolucijo o Dolgoročni podnebni strategiji zastavlja jasen cilj, da do leta 2050 doseže neto ničelne emisije oziroma podnebno nevtralnost.

Cilj bo dosežen z:

- Zmanjšanjem emisij in povečanjem odvzemov po ponorih
- Energetske učinkovitostjo
- Energijo iz obnovljivih virov energije

# Konkretni cilji zmanjševanja emisij in povečanja ponorov:

	Letne emisije TGP [kt CO <sub>2</sub> ekv]	Strateški sektorski cilji zmanjšanja glede na leto 2005
	2005	Podnebna strategija 2050
Promet	4.416,5	90–99 %
Energetika	6.974,5	90–99 %
Industrija	3.912,5	80–87 %
Kmetijstvo	1.732,8	5–22 %
Široka raba	2.680,0	87–96 %
Ravnanje z odpadki	740,5	75–83 %
SKUPAJ	20.456,8	80–90 %
LULUCF	-7.120,8	Ponor vsaj -2.500 kt CO <sub>2</sub> ekv
SKUPAJ	13.336	Doseganje neto ničelnih emisij TGP

## Cilji povečanja energetske učinkovitosti:

- raba končne energije v letu 2050 ne bo višja od 144 PJ in v letu 2040 ne bo višja od 169 PJ
- raba primarne energije v letu 2040 ne bo višja od 234 PJ

## Cilji pri rabi obnovljivih virov energije:

- Skupni delež OVE v končni rabi energije bo leta 2050 dosegel najmanj 60%, od tega najmanj 65-odstotni delež OVE v prometu, najmanj 50-odstotni delež OVE pri ogrevanju in hlajenju ter najmanj 80-odstotni delež OVE v bruto končni rabi električne energije.



# Obnovljivi viri energije

## ➤ **Sončna energija**

- direktna vpadla sončna energija:
  - ✓ sprejemniki toplote
  - ✓ sončne celice (fotovoltaika – neposredna pretvorba svetlobe v električno energijo)
- indirektna vpadla sončna energija
  - ✓ biomasa
  - ✓ geodetska potencialna energija vodnih mas
  - ✓ energija vetra
  - ✓ energija morja
    - ❖ energija morskih tokov
    - ❖ energija valov
    - ❖ notranja energija morja
- **Kalorična notranja energija zemeljske skorje**
  - geotermalna voda
- **Gravitacijska energija**
  - energija bibavice



A stylized sun icon composed of three horizontal grey bars. The top and bottom bars have rounded ends, while the middle bar is a simple rectangle. The text "Sončna energija" is centered over the middle bar.

# Sončna energija

# Povprečno letno sončno obsevanje v Sloveniji

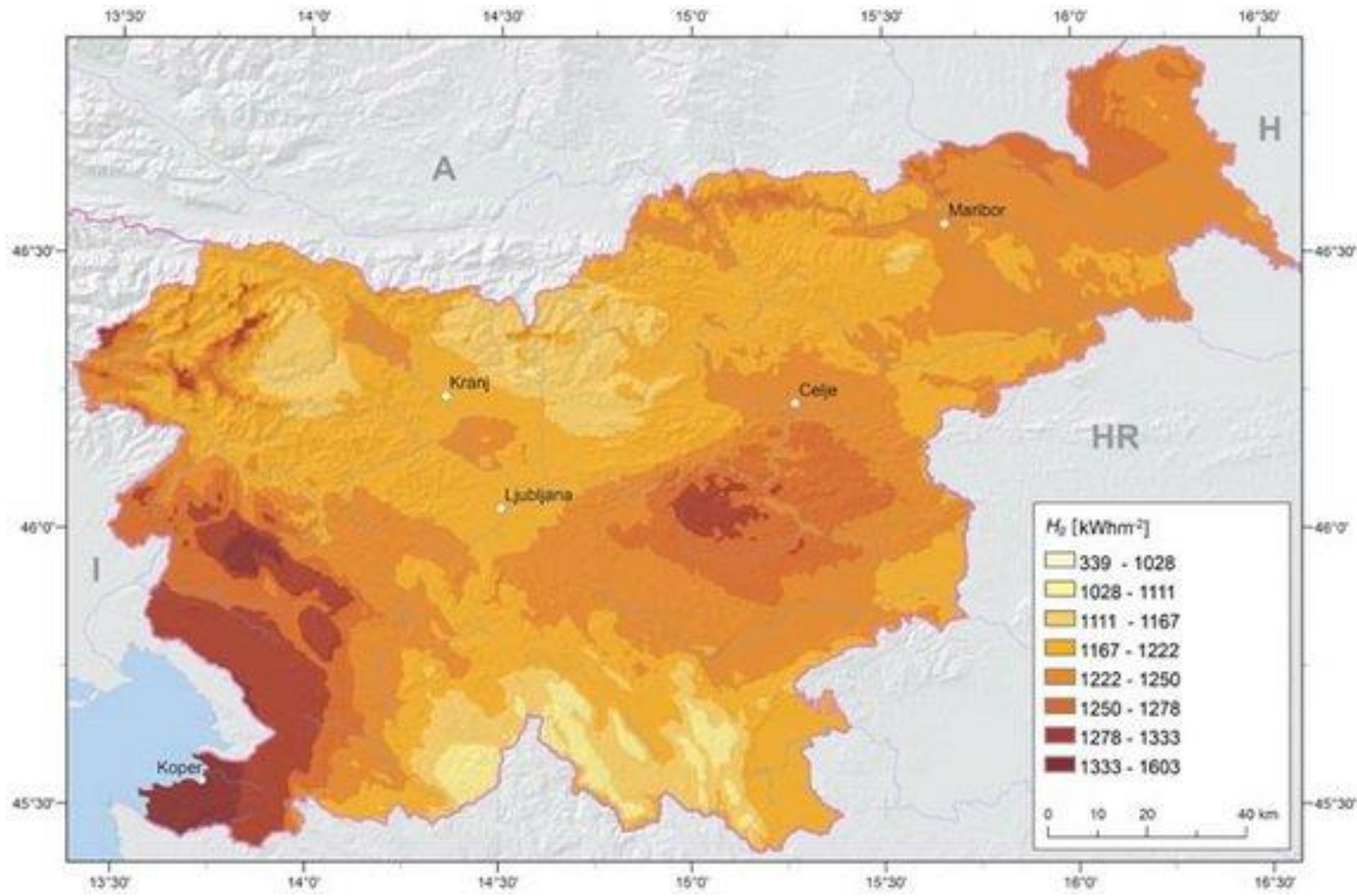

(Vir: D. Kastelec, J. Rakovec, K. Zakšek, Sončna energija v Sloveniji, ZRC SAZU, 2007, str. 76)

# Solarni ogrevalni sistemi

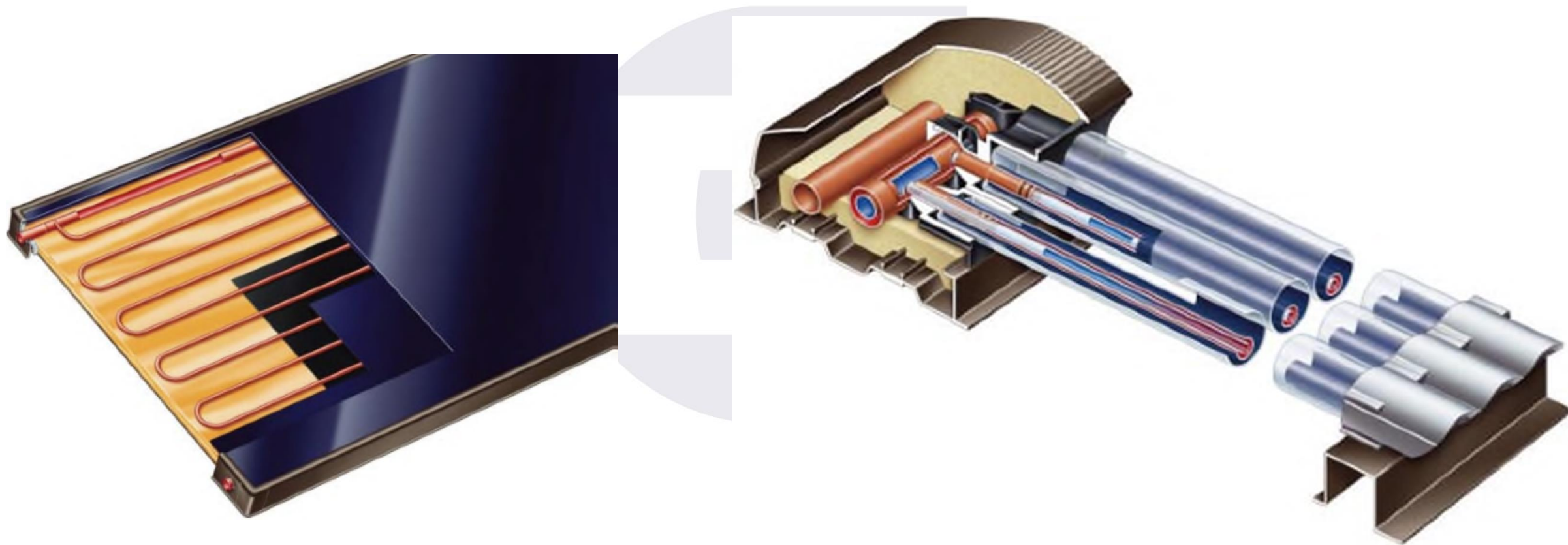

# Solarni ogrevalni sistemi

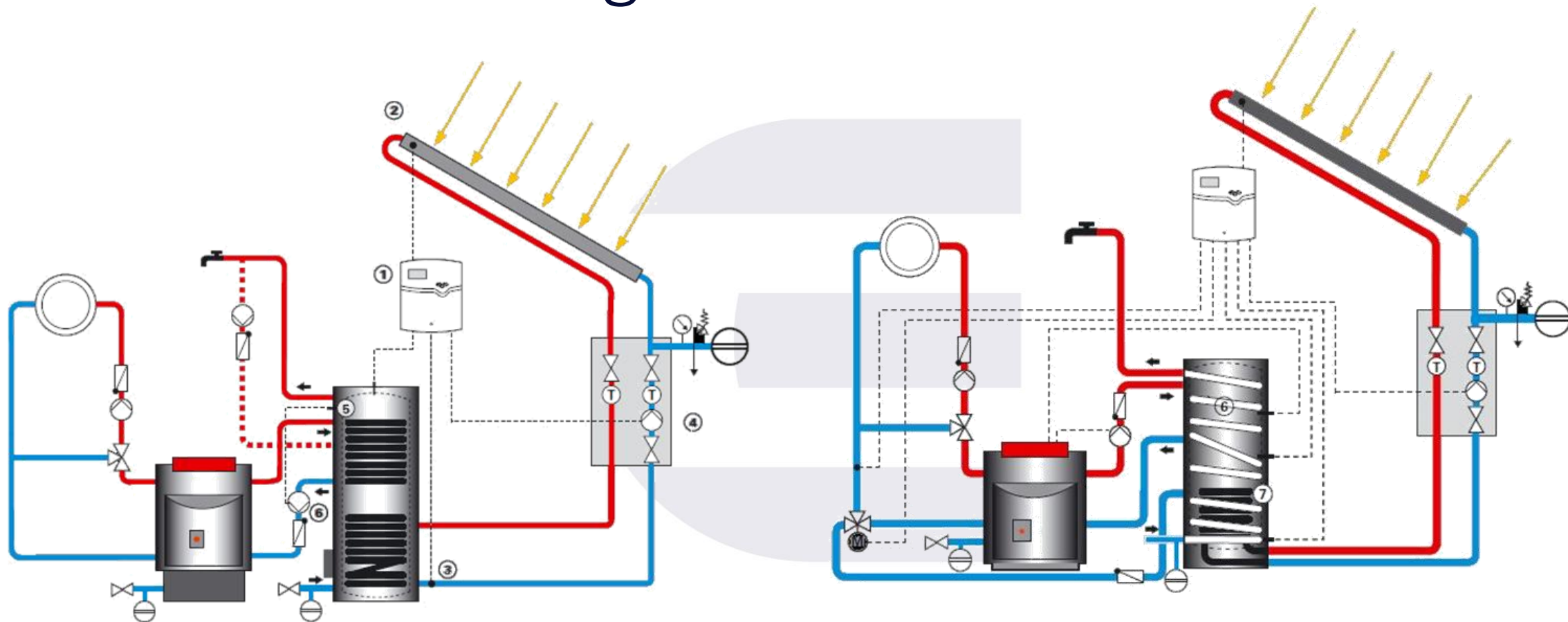

Ogrevanje sanitarne vode

Ogrevanje sanitarne vode in ogrevanje prostorov

## Solarni ogrevalni sistemi

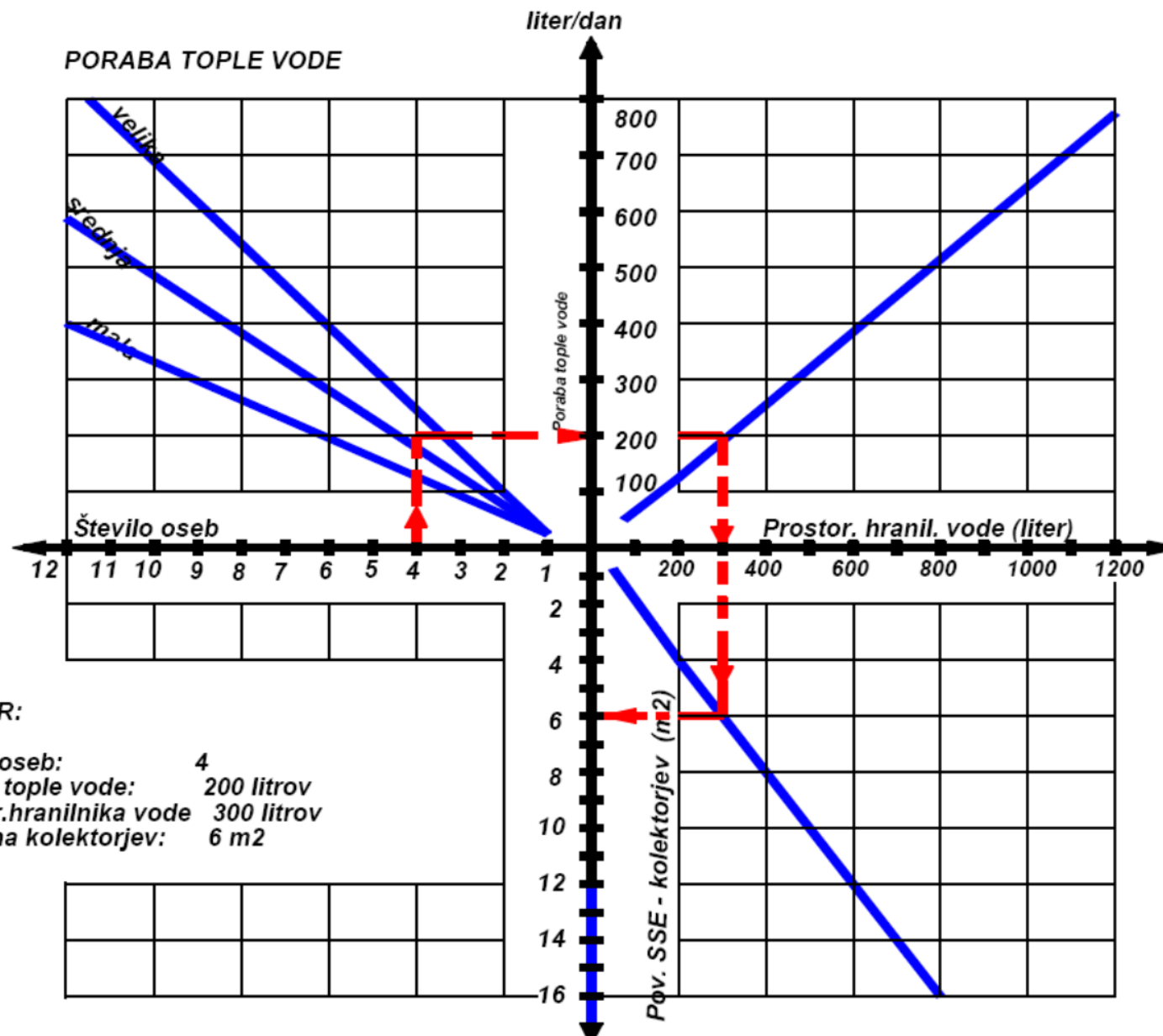

## Fotovoltaična elektrarna

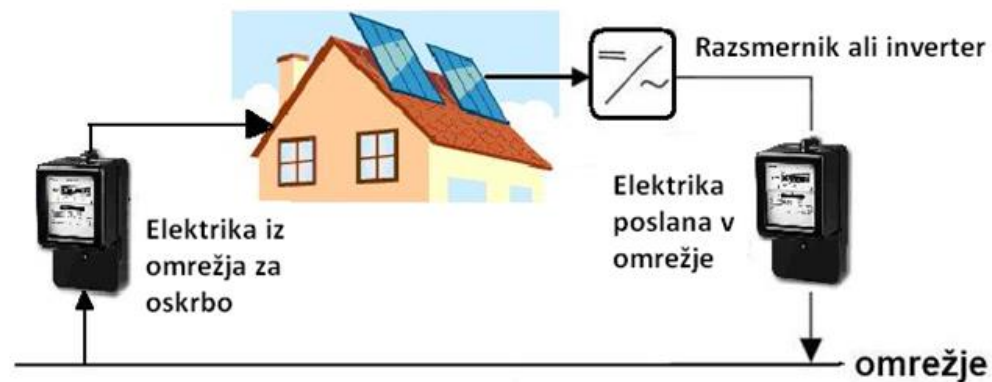
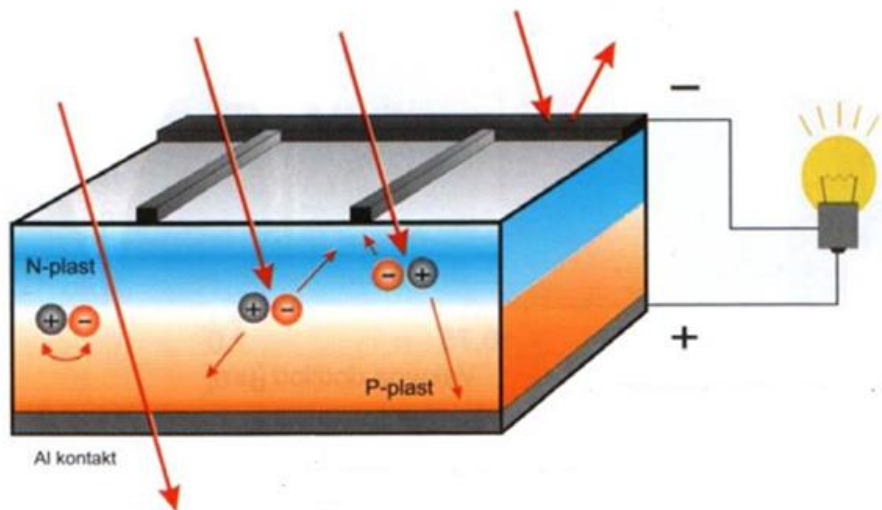

## Proizvodnja sončnih celic

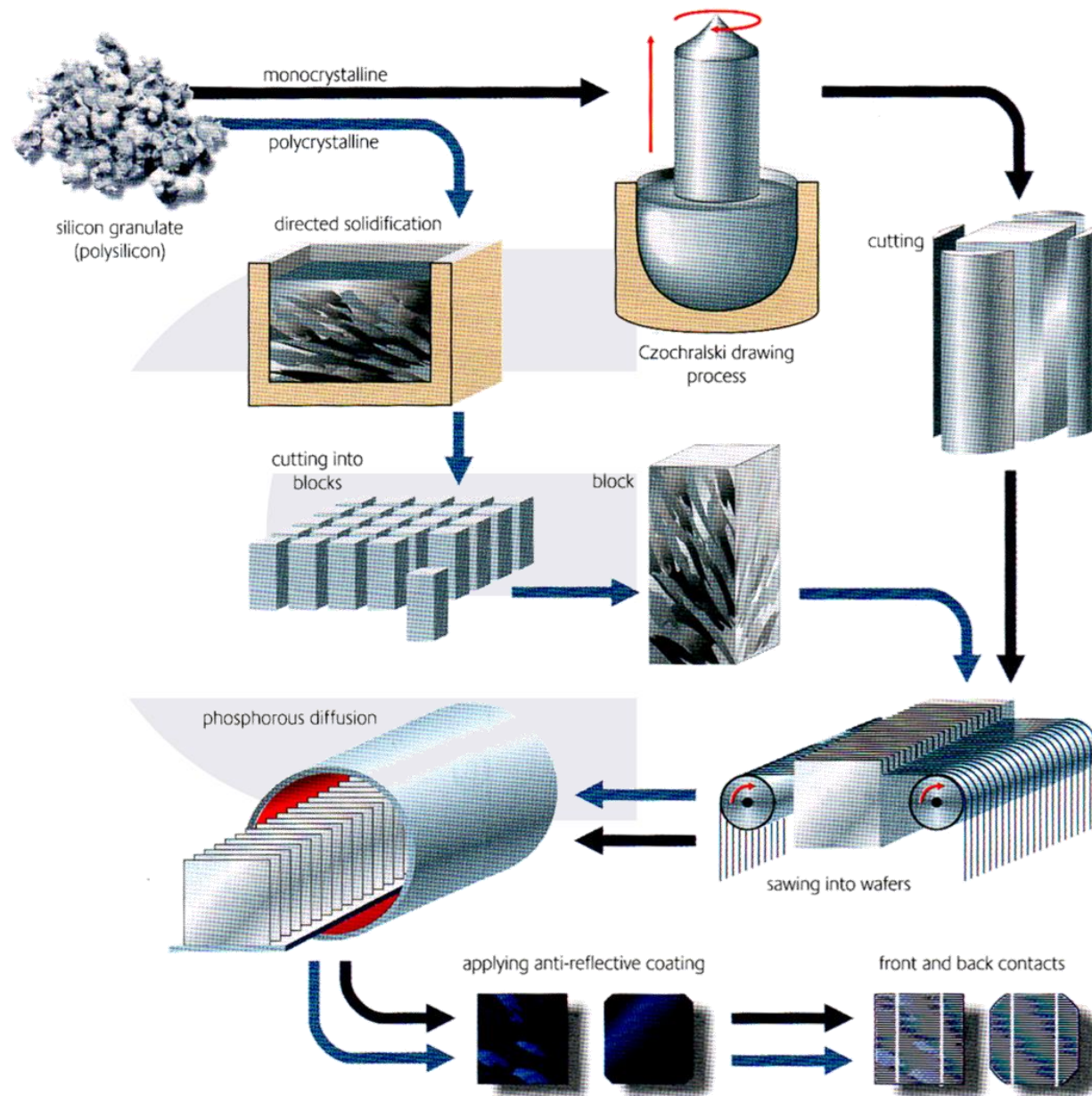

# U-I krivulja kristalne silicijeve sončne celice

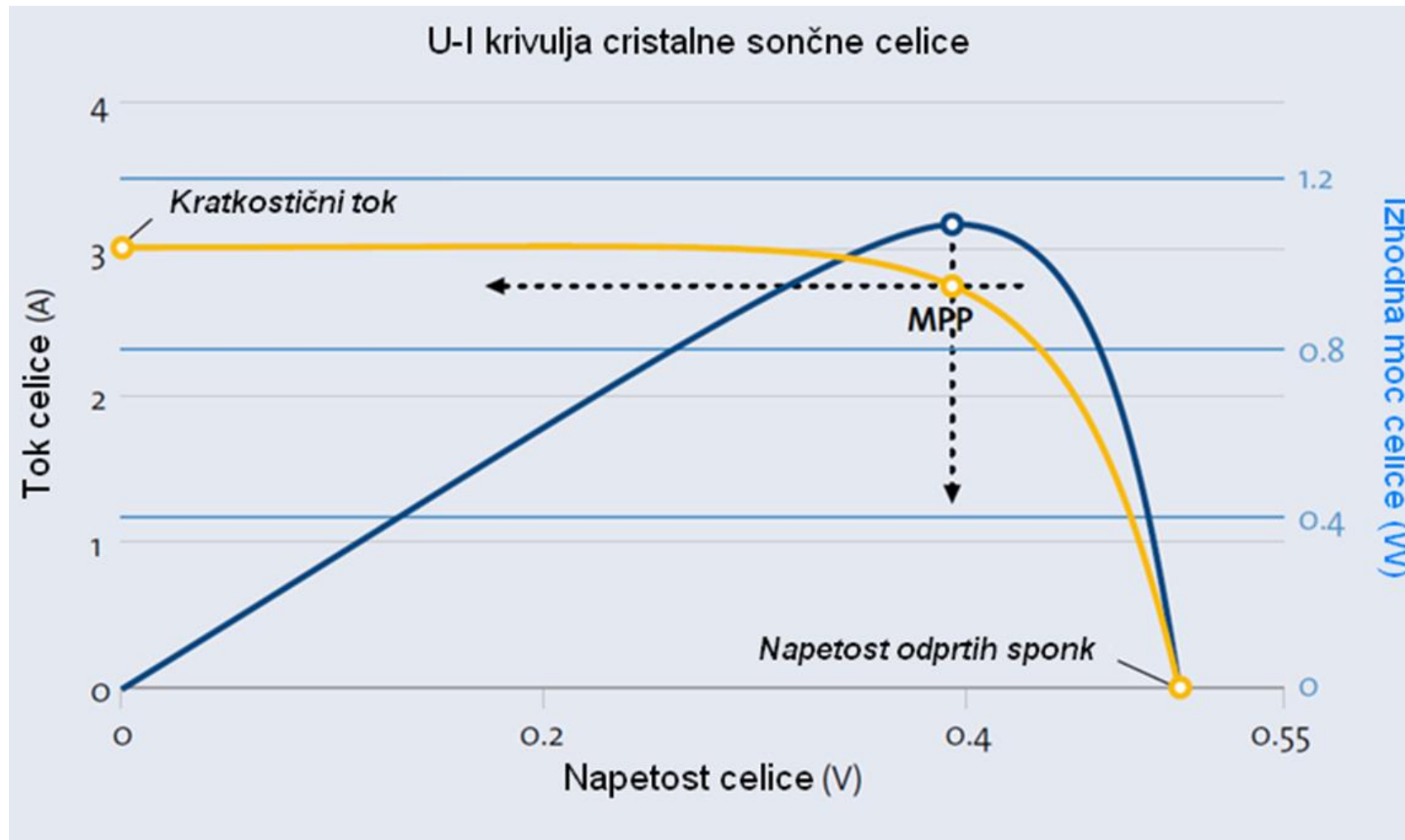



# Nadomestno vezje sončne celice

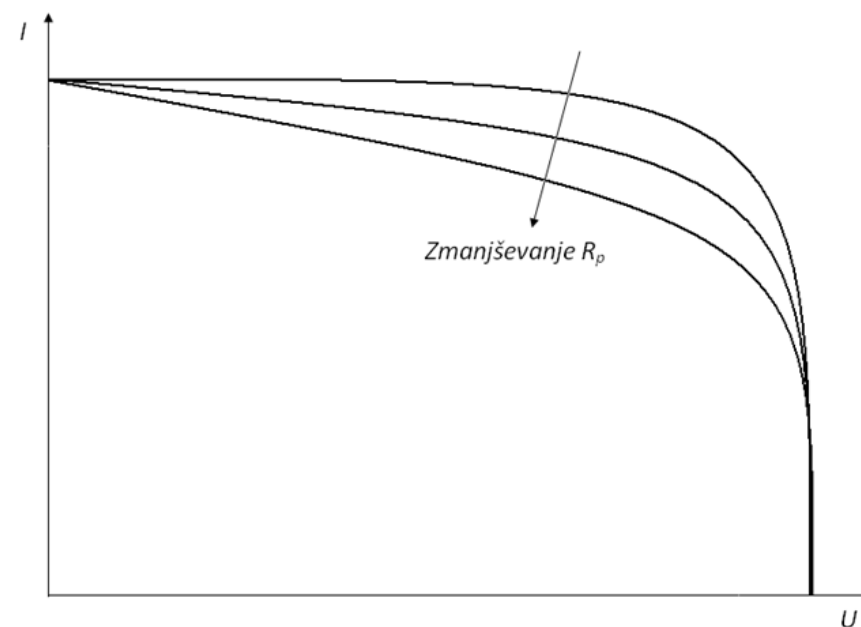
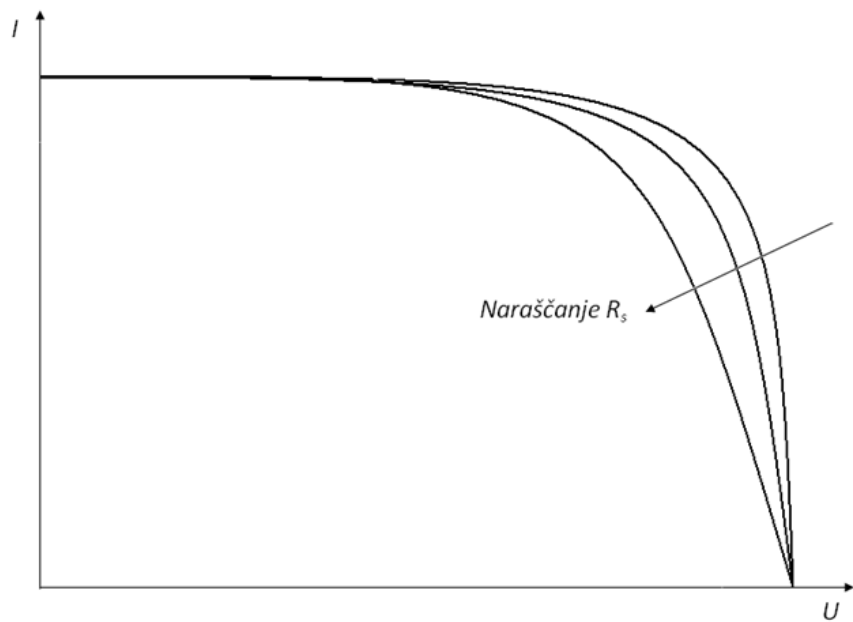
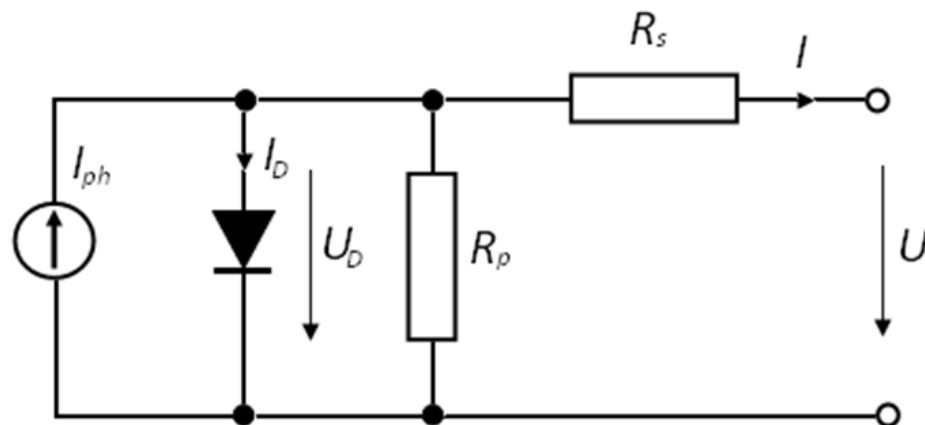

# Zaporedna vezava sončnih celic

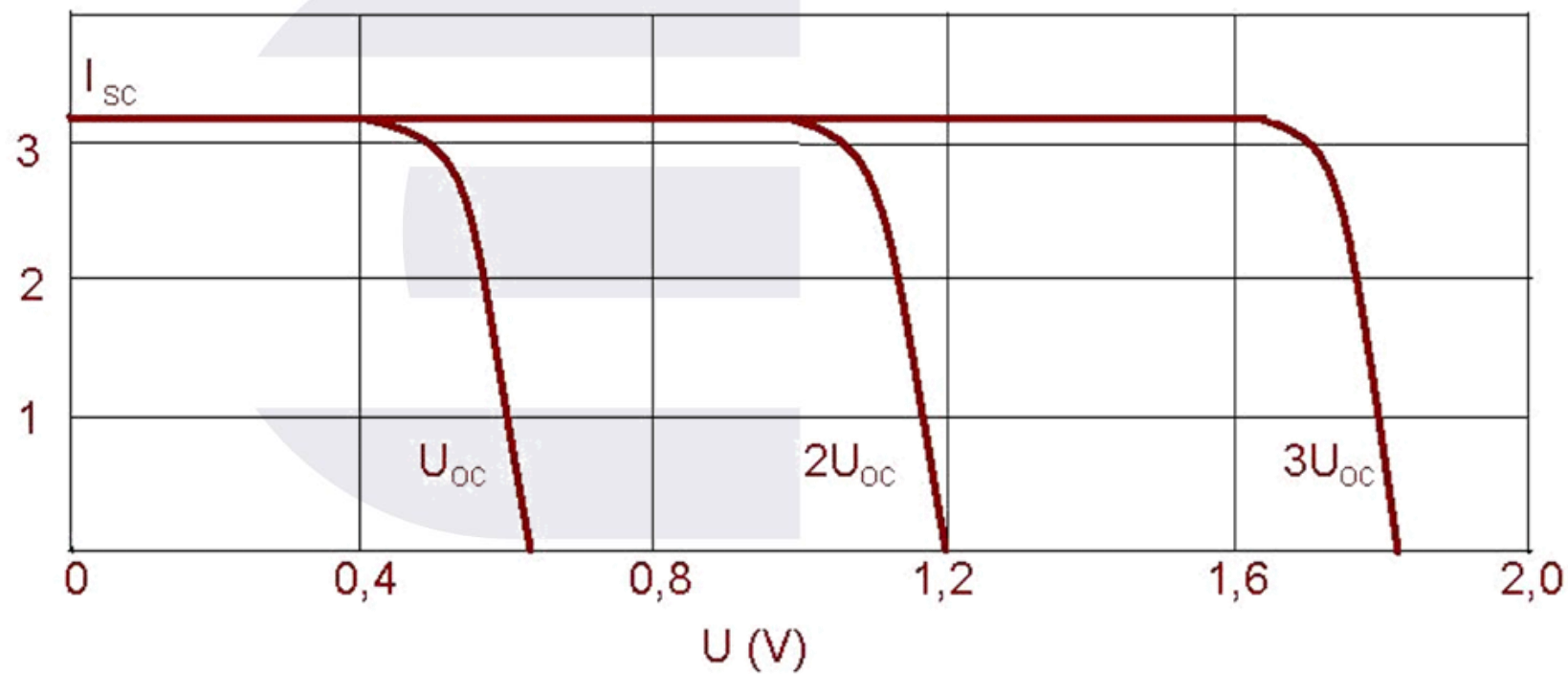
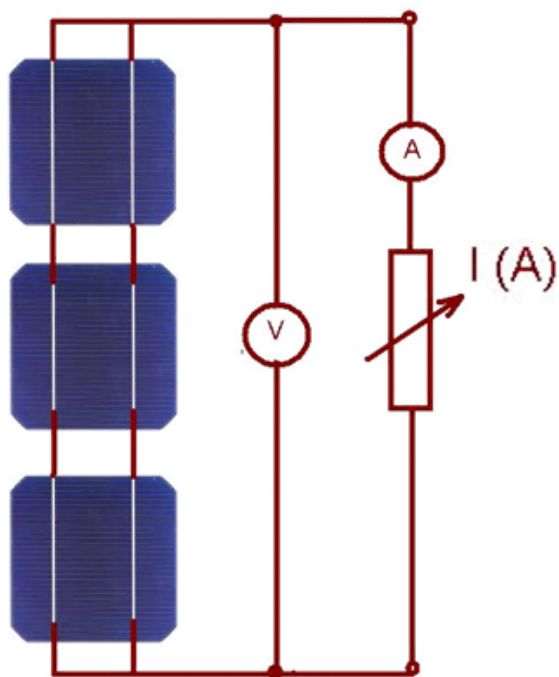

# Vzporedna vezava sončnih celic

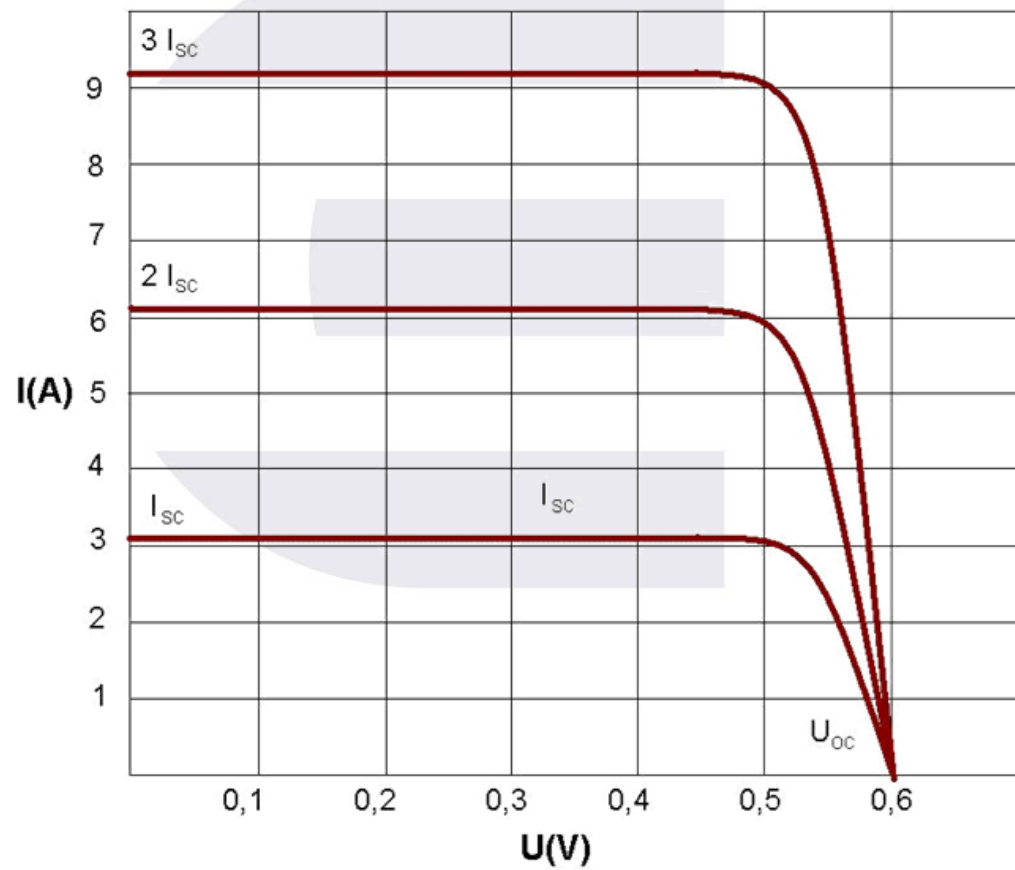
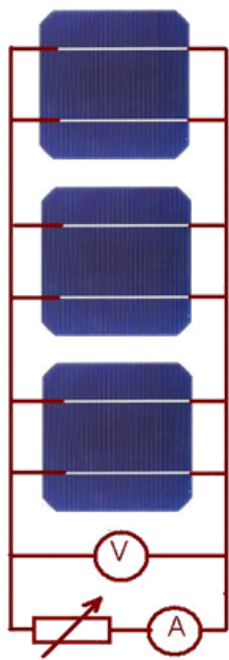

# Temperaturni koeficienti kristalnih sončnih celic

Kratkostični tok:

$$\Delta I_{SC} (\alpha) = +0,02 \text{ } \%/^{\circ}\text{C} \text{ do } +0,1 \text{ } \%/^{\circ}\text{C}$$

Napetost odprtih sponk:

$$\Delta U_{OC} (\beta) = -0,30 \text{ } \%/^{\circ}\text{C} \text{ do } -0,41 \text{ } \%/^{\circ}\text{C}$$

Moč v točki MPP:

$$\Delta P_{MPP} (\gamma) = -0,37 \text{ } \%/^{\circ}\text{C} \text{ do } -0,55 \text{ } \%/^{\circ}\text{C}$$

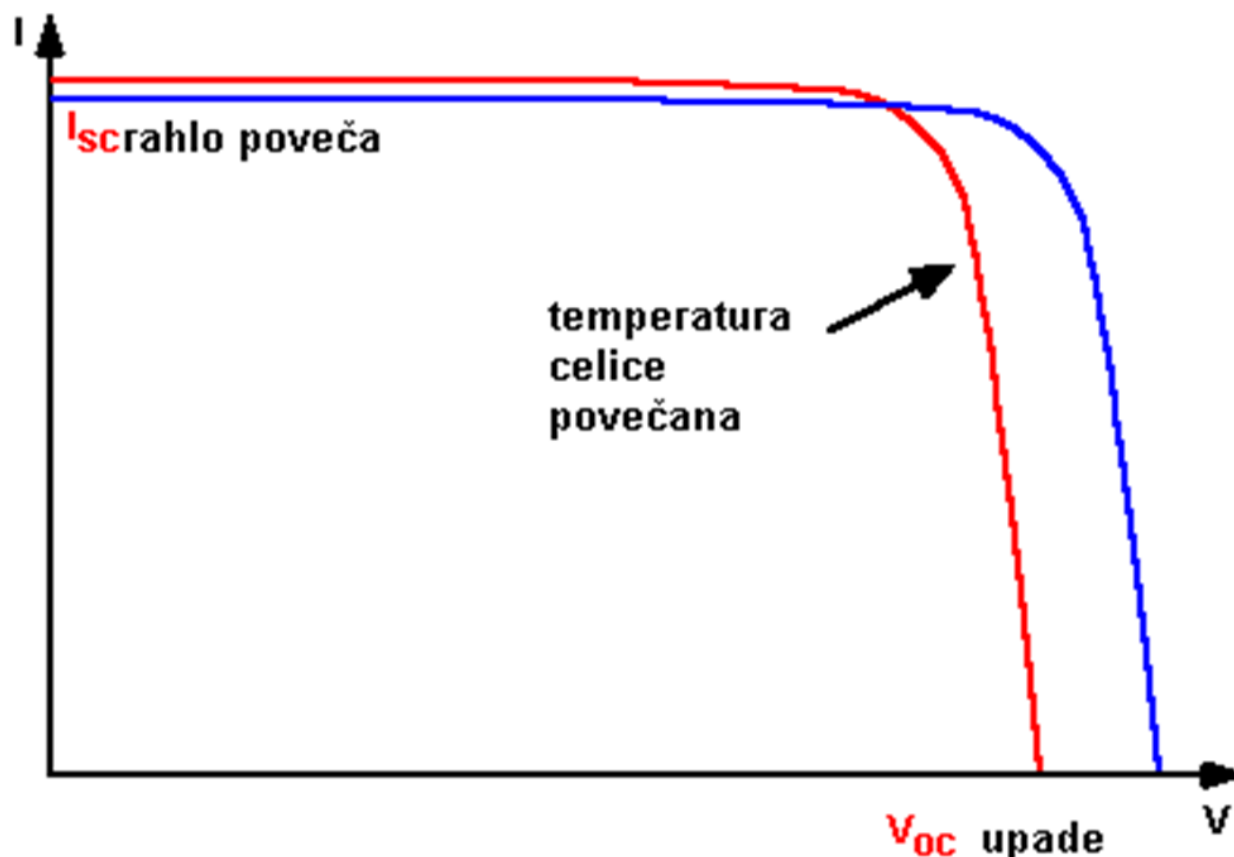

# Vpliv temperature okolice na moč modula

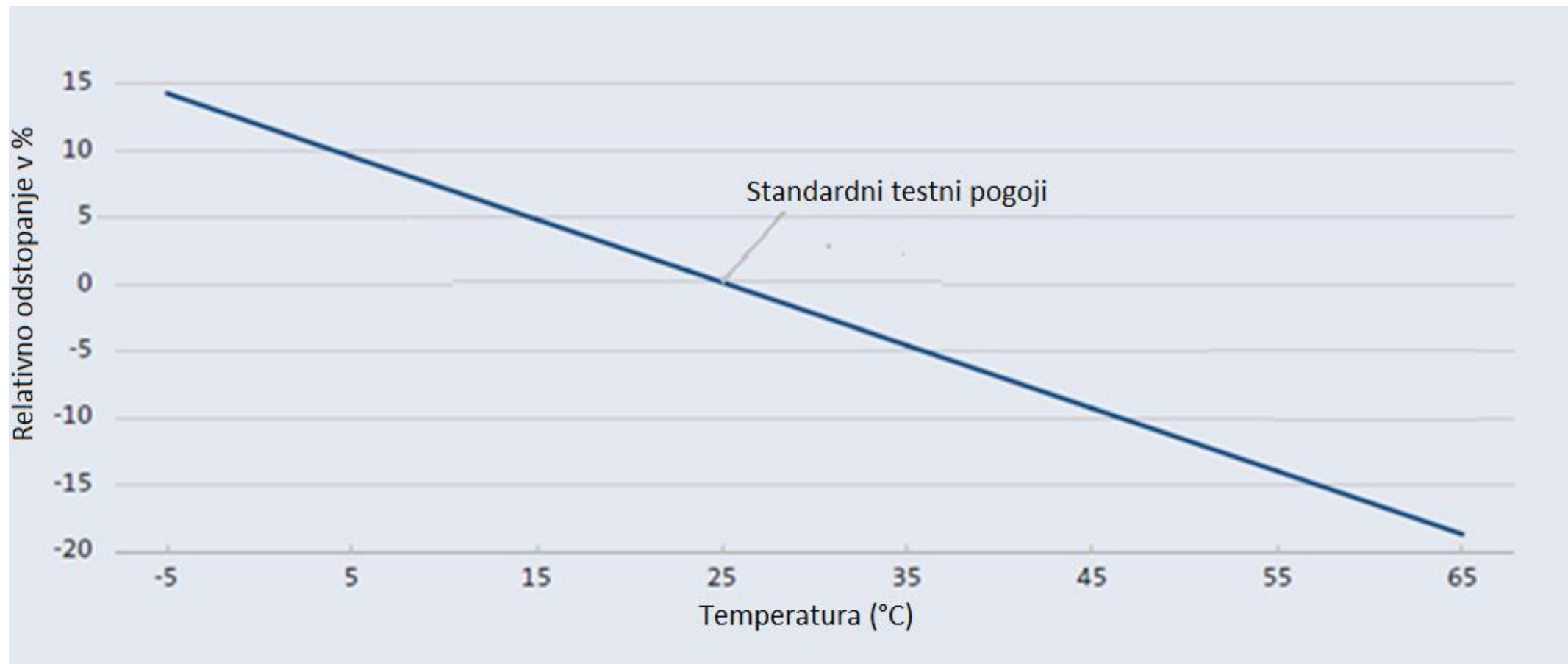

# Konkretni primer vpliva temperature na moč MFE

7. februar 2013

Temperatura zraka ob 14 uri:

0°C

7. avgust 2013

Temperatura zraka ob 14 uri:

36°C

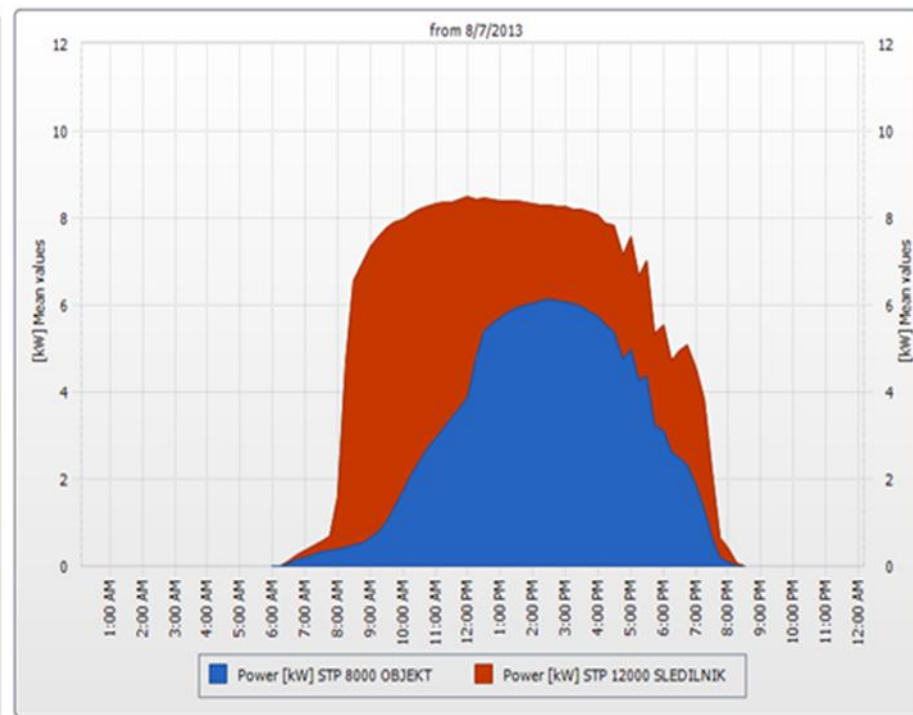
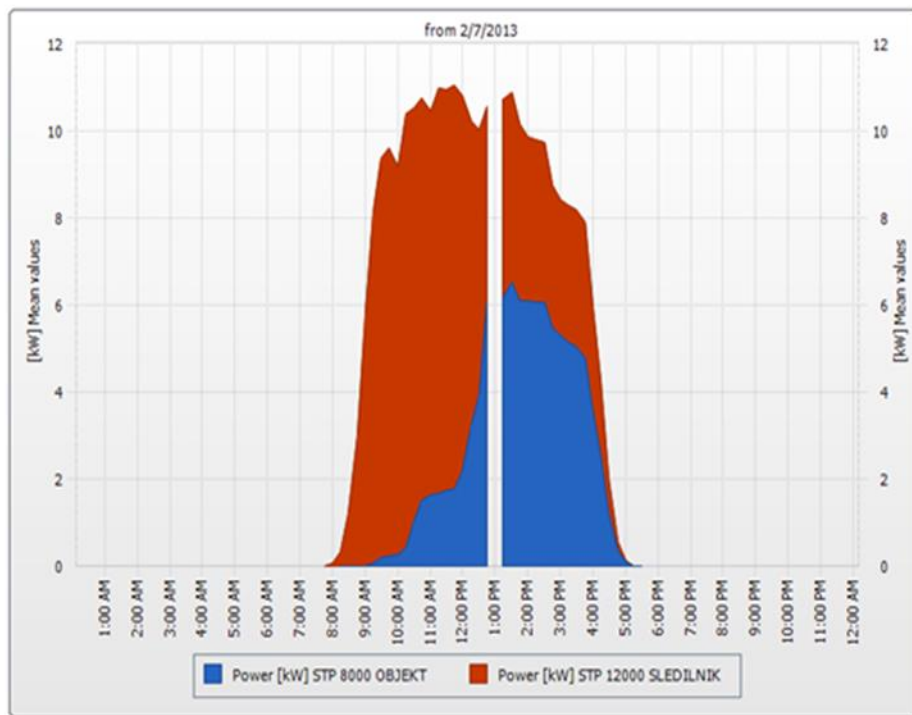

# Vpliv lege panela na izgubo moči

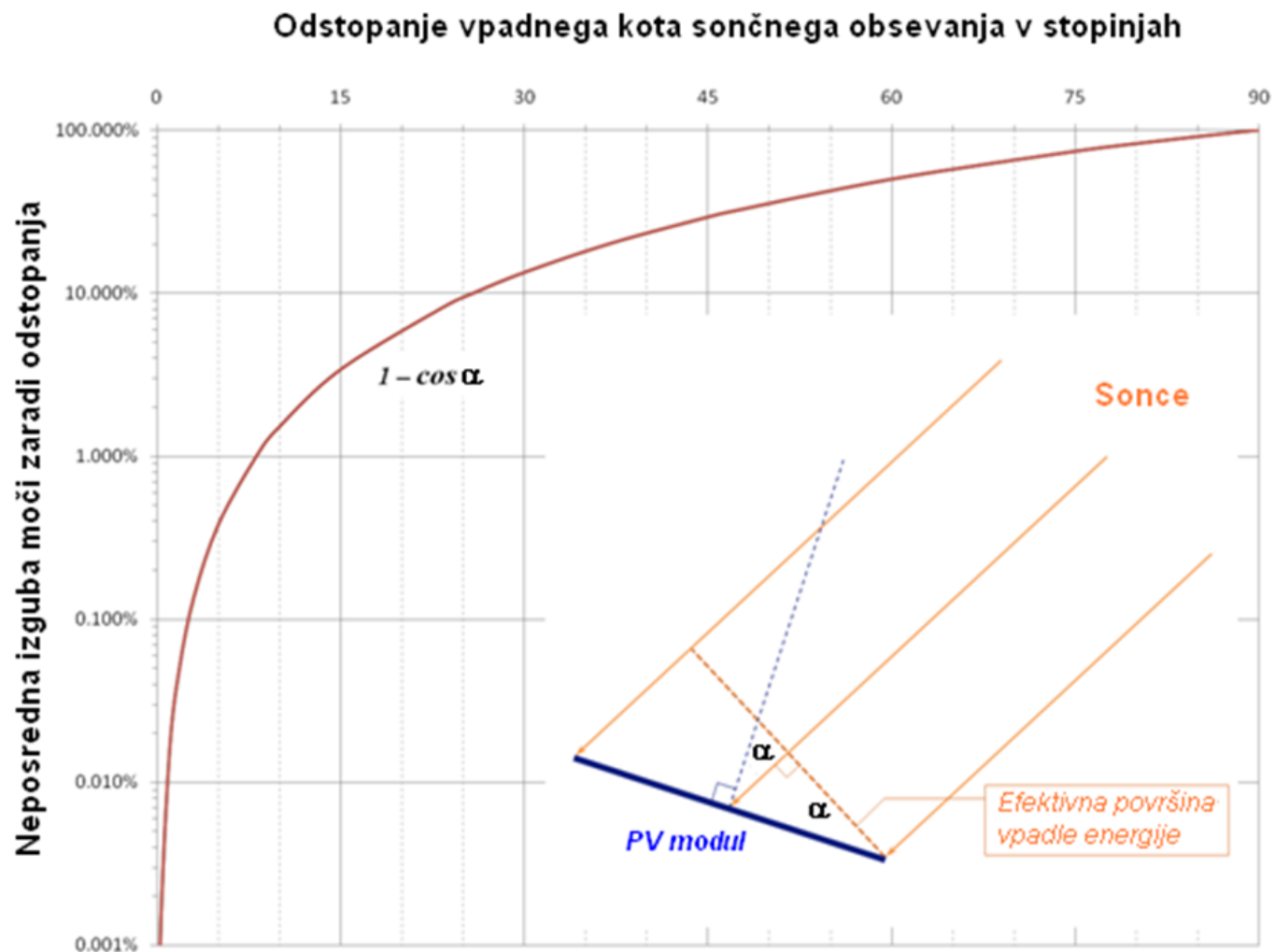

# Postavitev panelov glede na letni čas

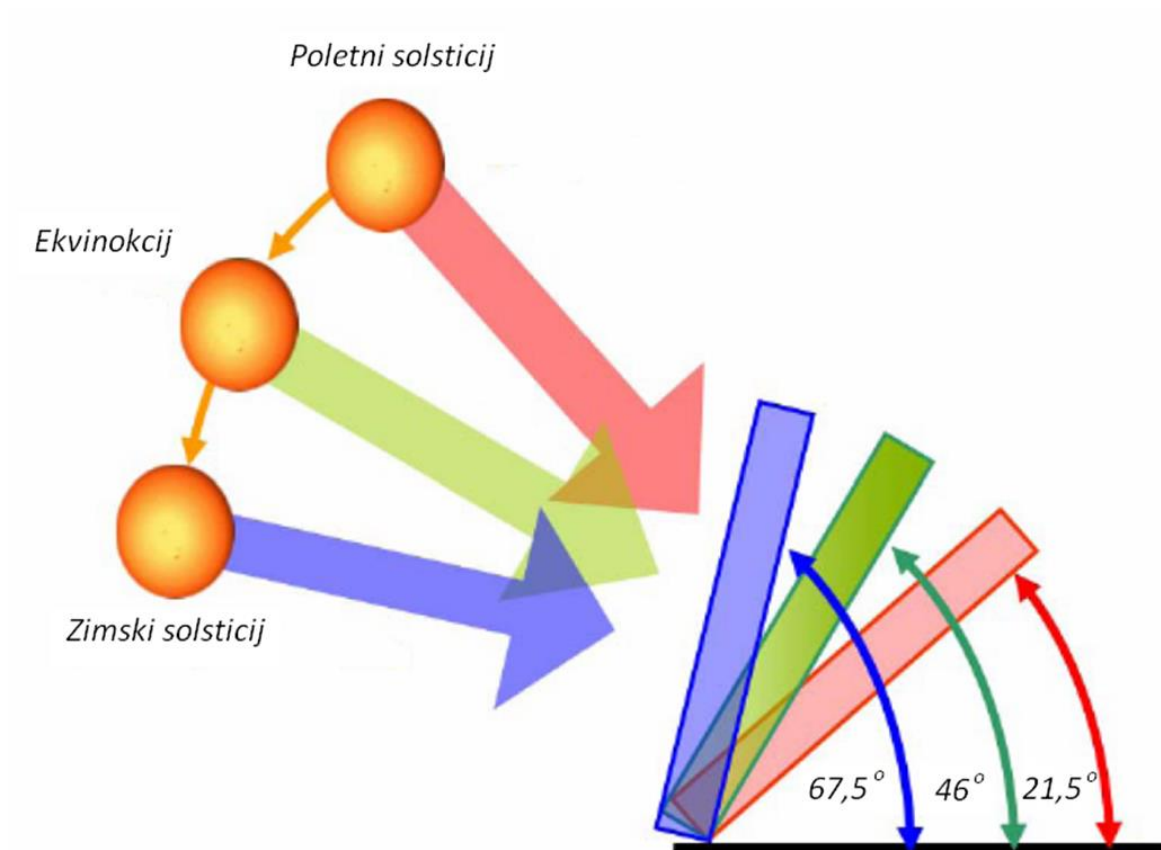



# Povečanje izkoristka sistema s sledenjem soncu

Eno osno sledenje soncu

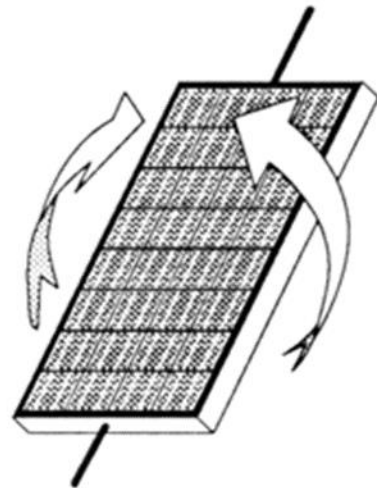

Primarna os obrača modul  
v smeri vzhod- zahod

Dvo osno sledenje soncu

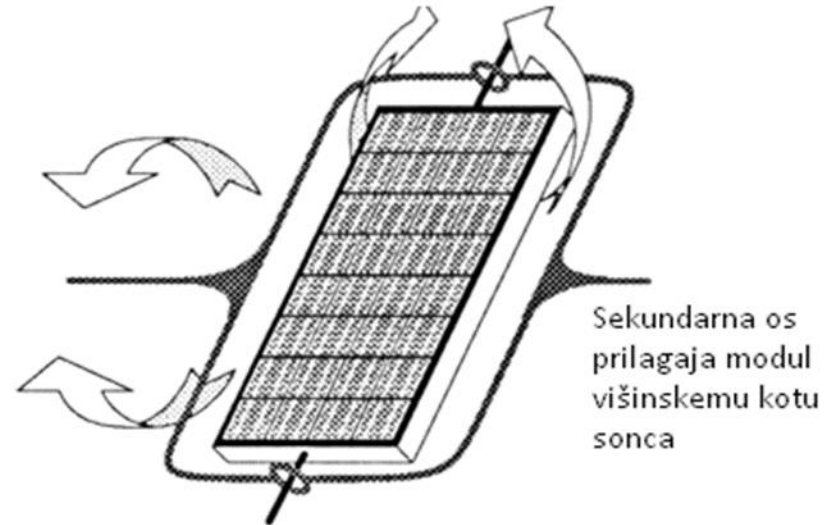

Sekundarna os  
prilagaja modul  
višinskemu kotu  
sonca

Primarna os obrača modul  
v smeri vzhod- zahod

# Evropski izkoristek inverterja

Določanje evropskega izkoristka inverterja (velja za srednjo Evropo)

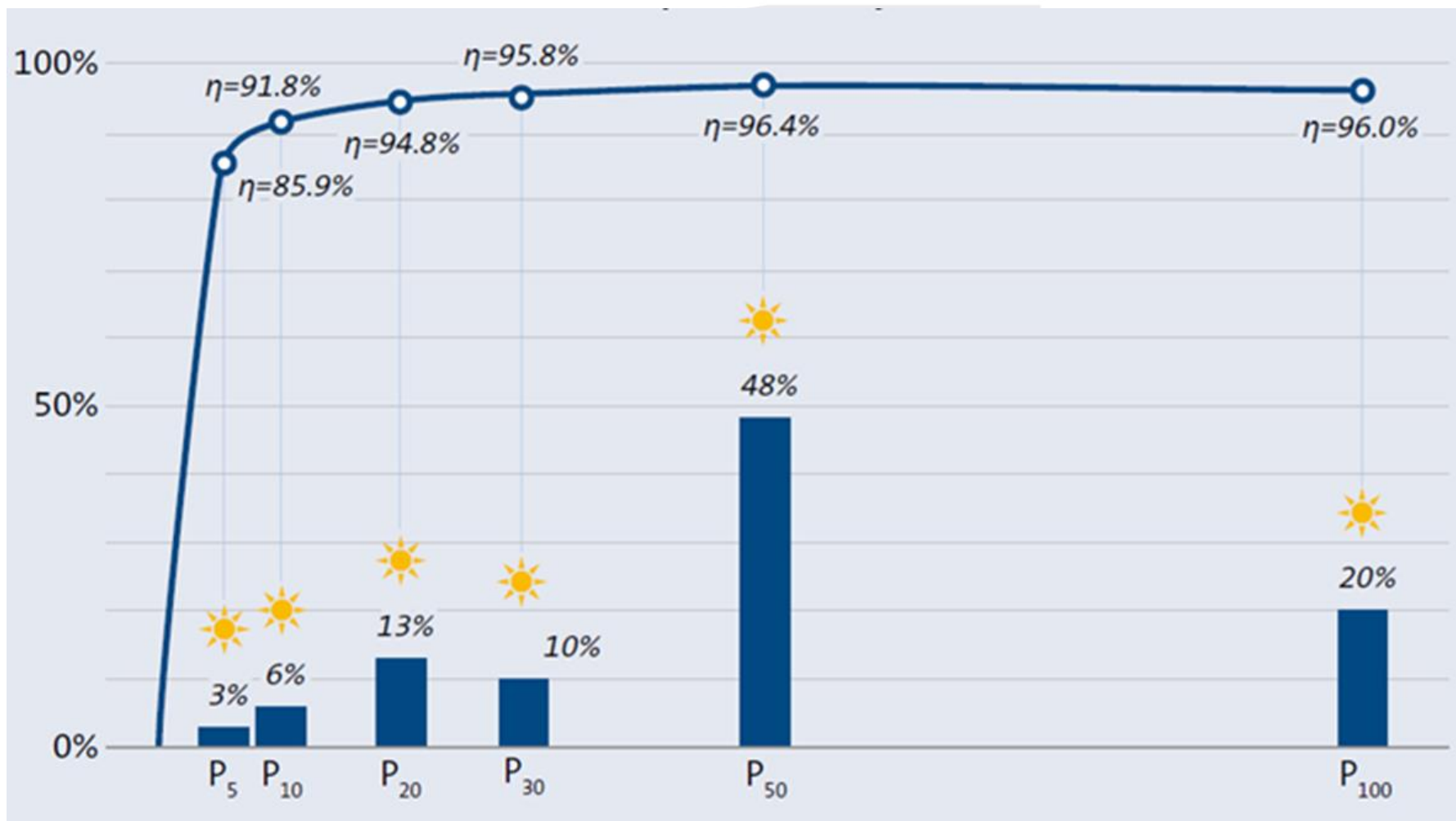

# Evropski izkoristek inverterja (konkretni primer)

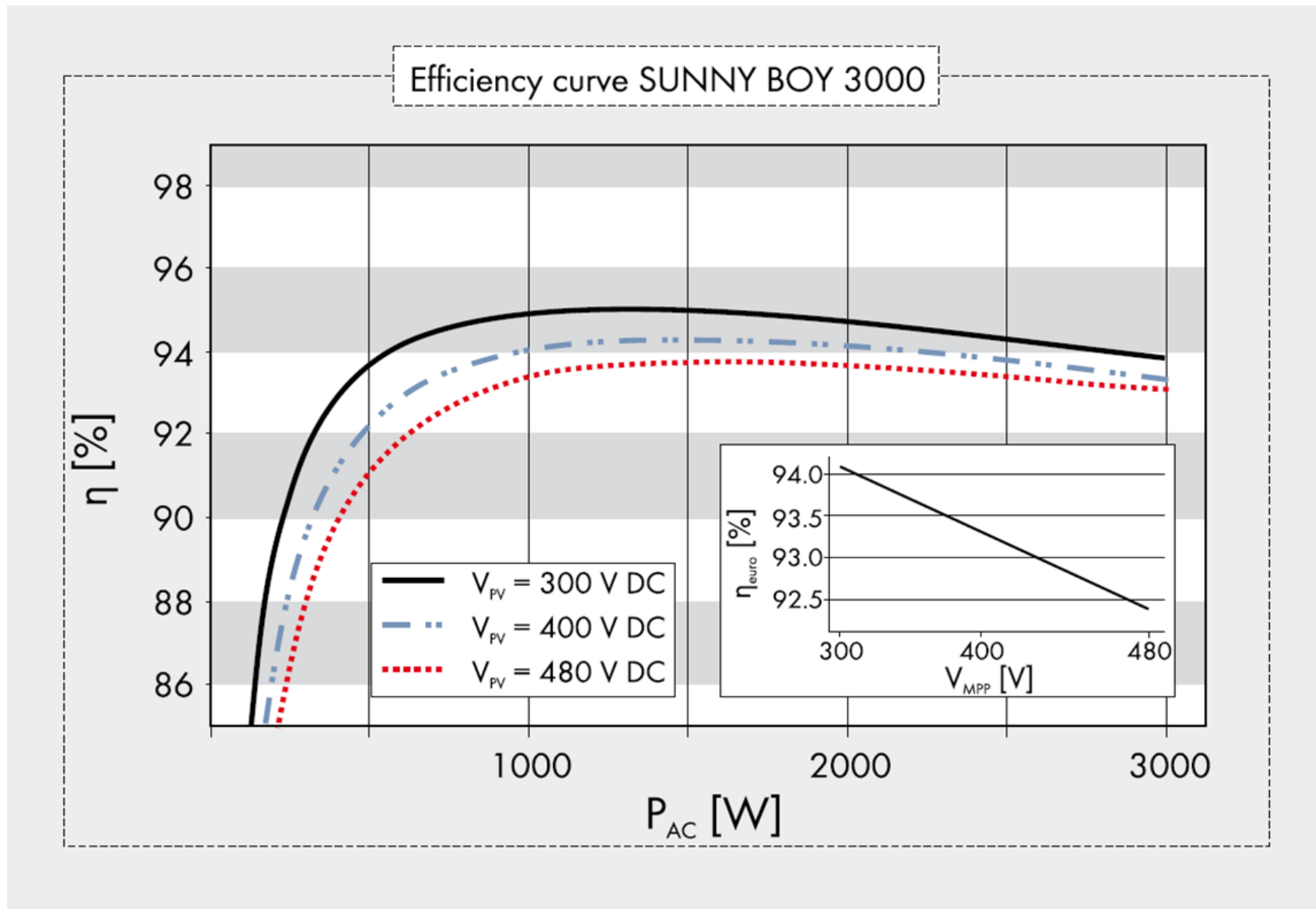

# Poti do večje proizvodnje električne energije

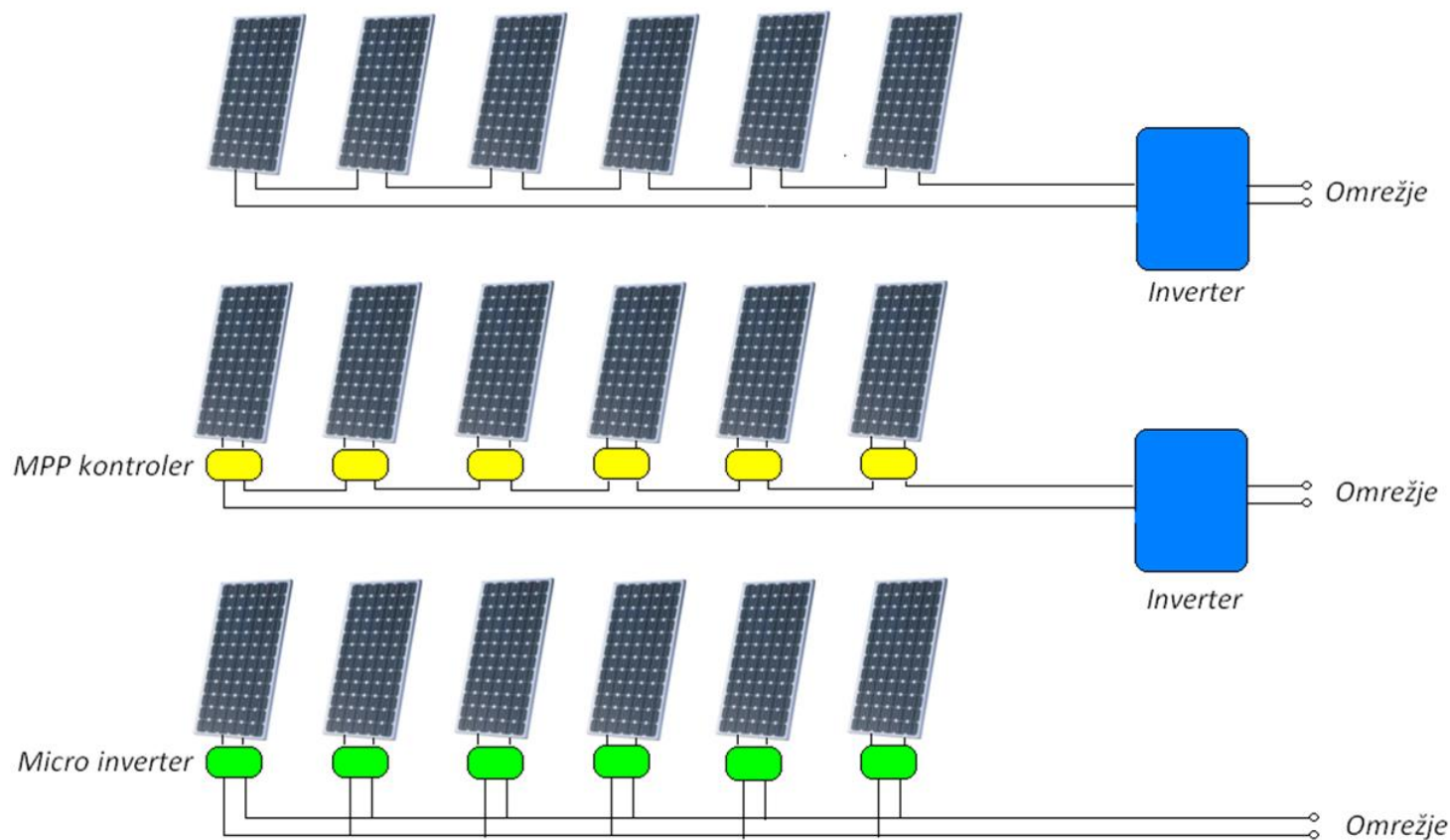

# Nadzor maksimalne moči modula

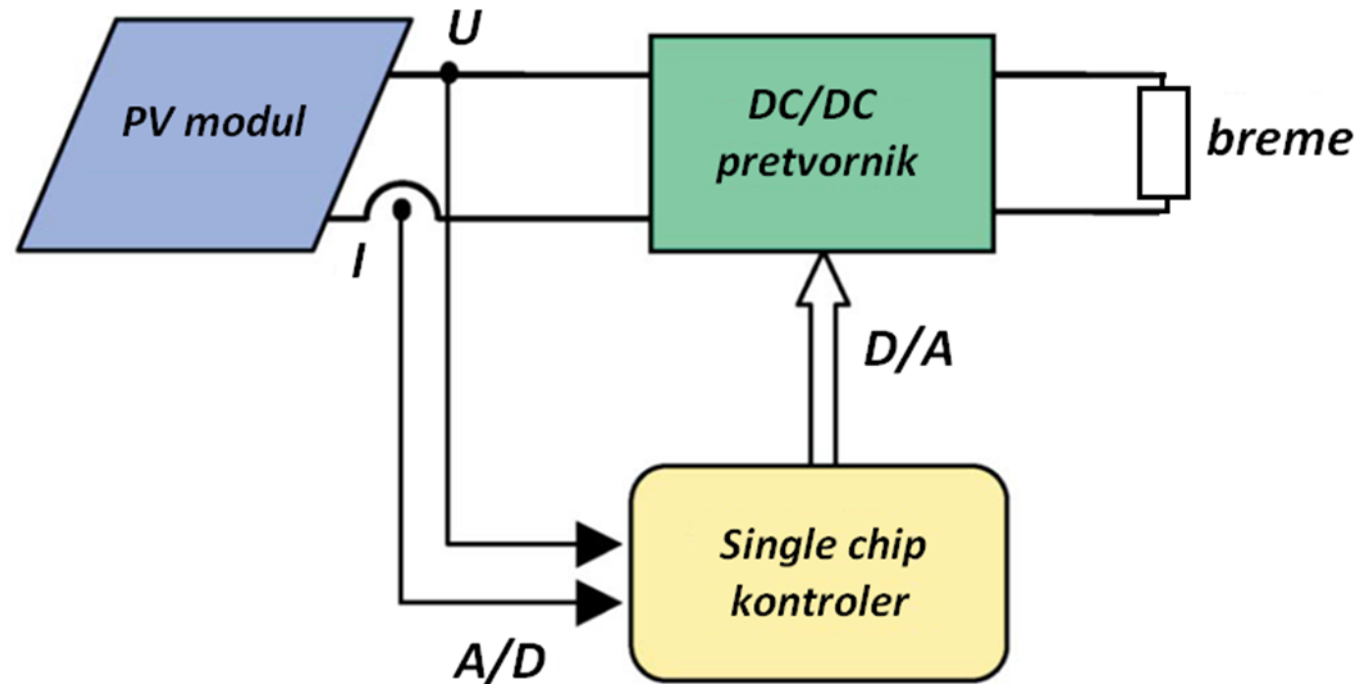

# Micro inverter na vsakem modulu



# Strma rast fotovoltaičnih elektrarn v svetu

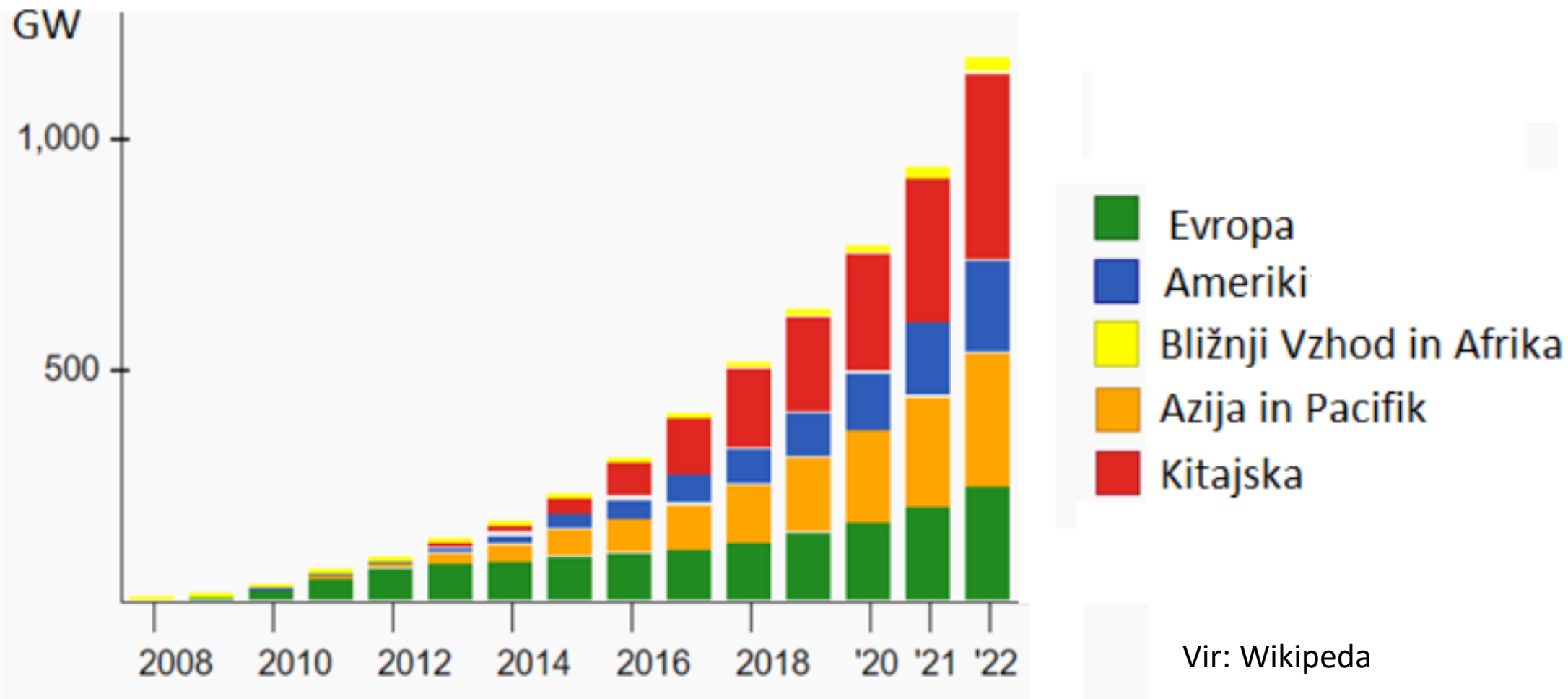

# Sončna termoelektrarna s parabolnimi koriti

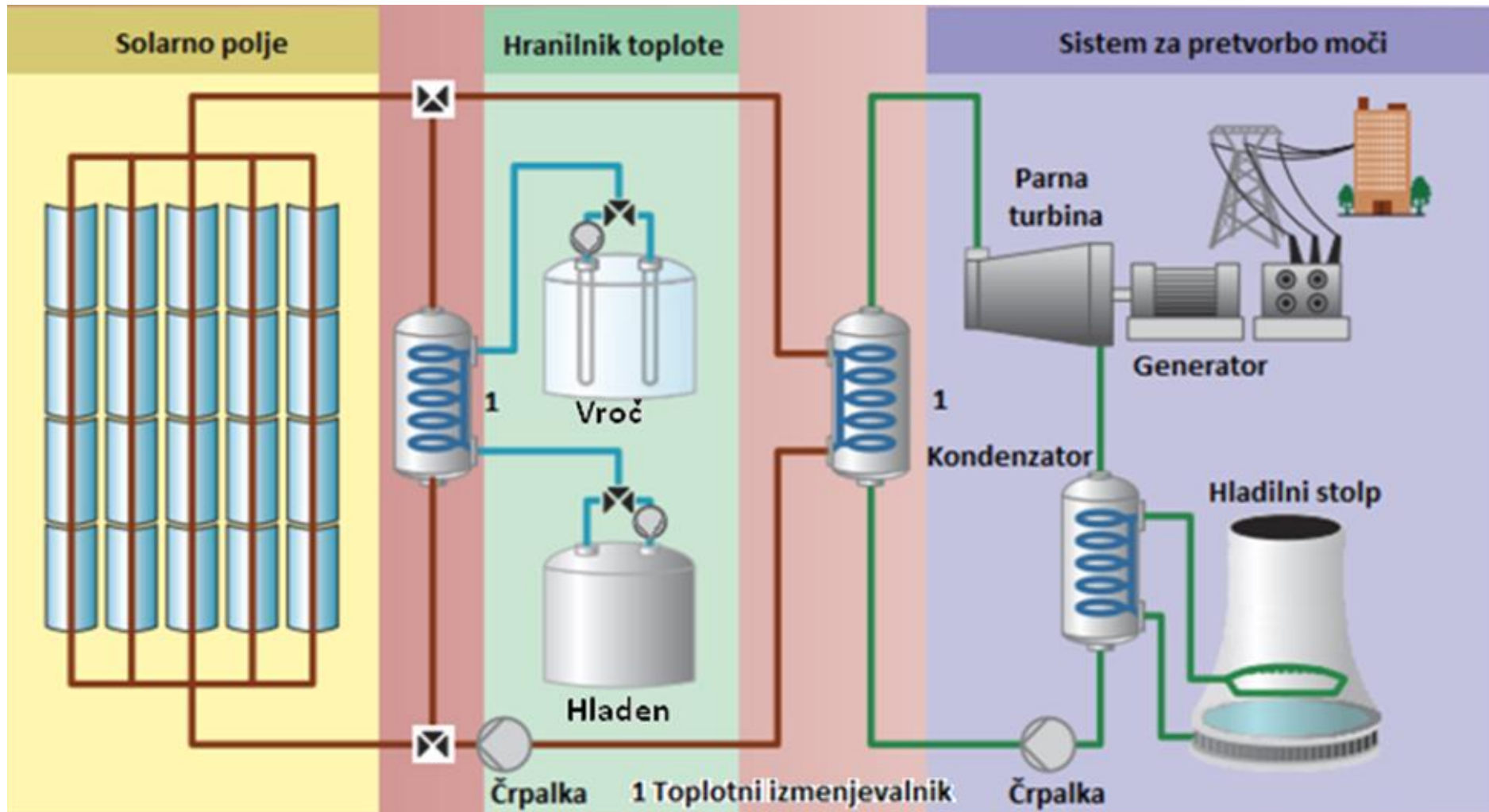



# Sončna termoelektrarna Andasol v Španiji



# Sončna termoelektrarna Andasol, Španija



Prva evropska komercialna sončna termoelektrarna.

Trije sistemi, vsak 50MW.

Letna proizvodnja 180GWh.

Skupna površina 200 ha.

Hranilniki toplote imajo zmogljivost 1000MWh in omogočajo 7,5 ure obratovanja pri polni moči.

# Sončna stolpna termoelektrarna

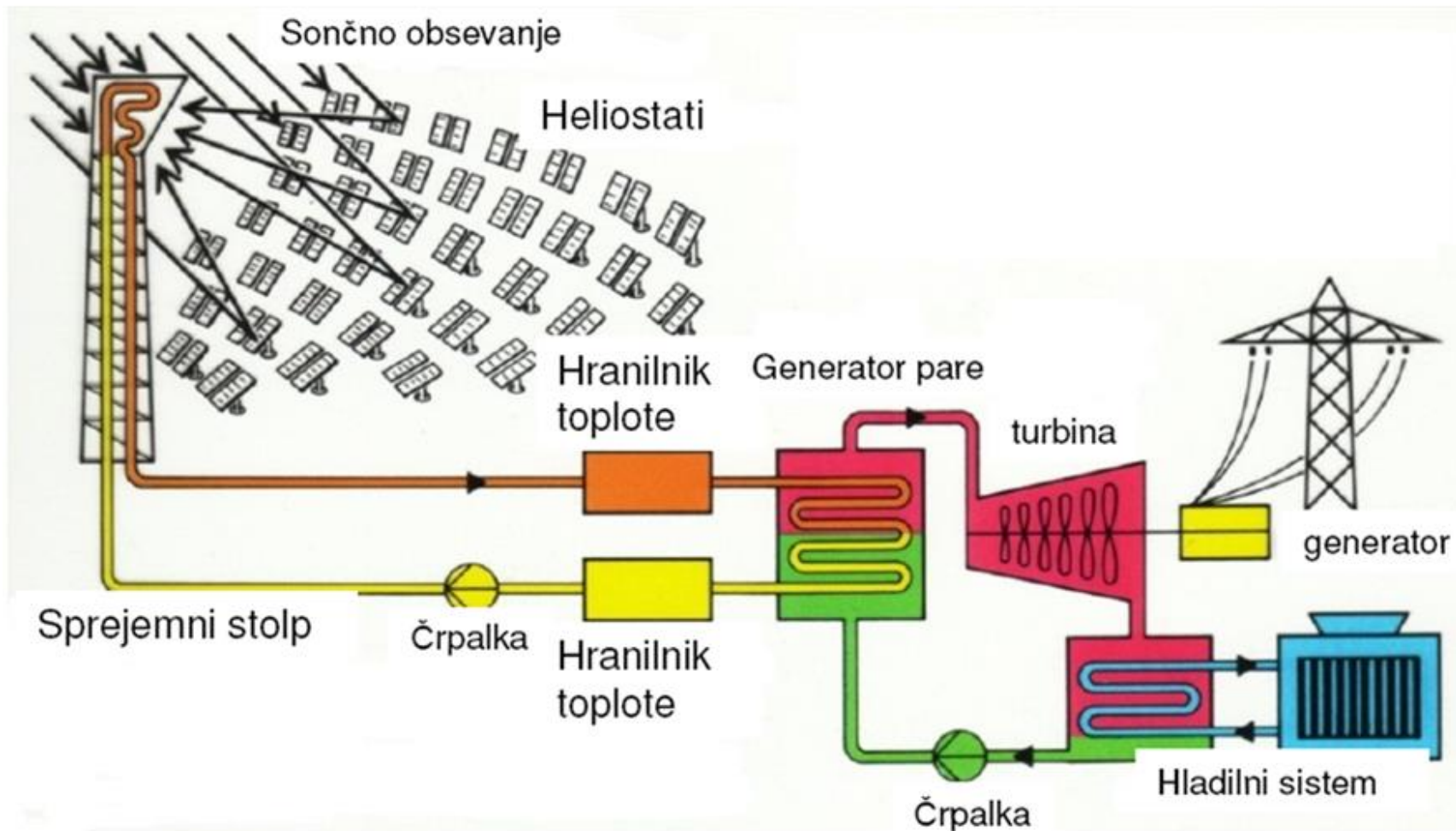

# Sončna termoelektrarna Ivanpah v Kaliforniji



392 MW, površina 14,2 km<sup>2</sup>  
več kot 300.000 heliostatov,  
uparjalniki visoki 140 m

# Sončna elektrarna s paraboloidnimi zrcali



# Rast sončnih termoelektrarn v svetu

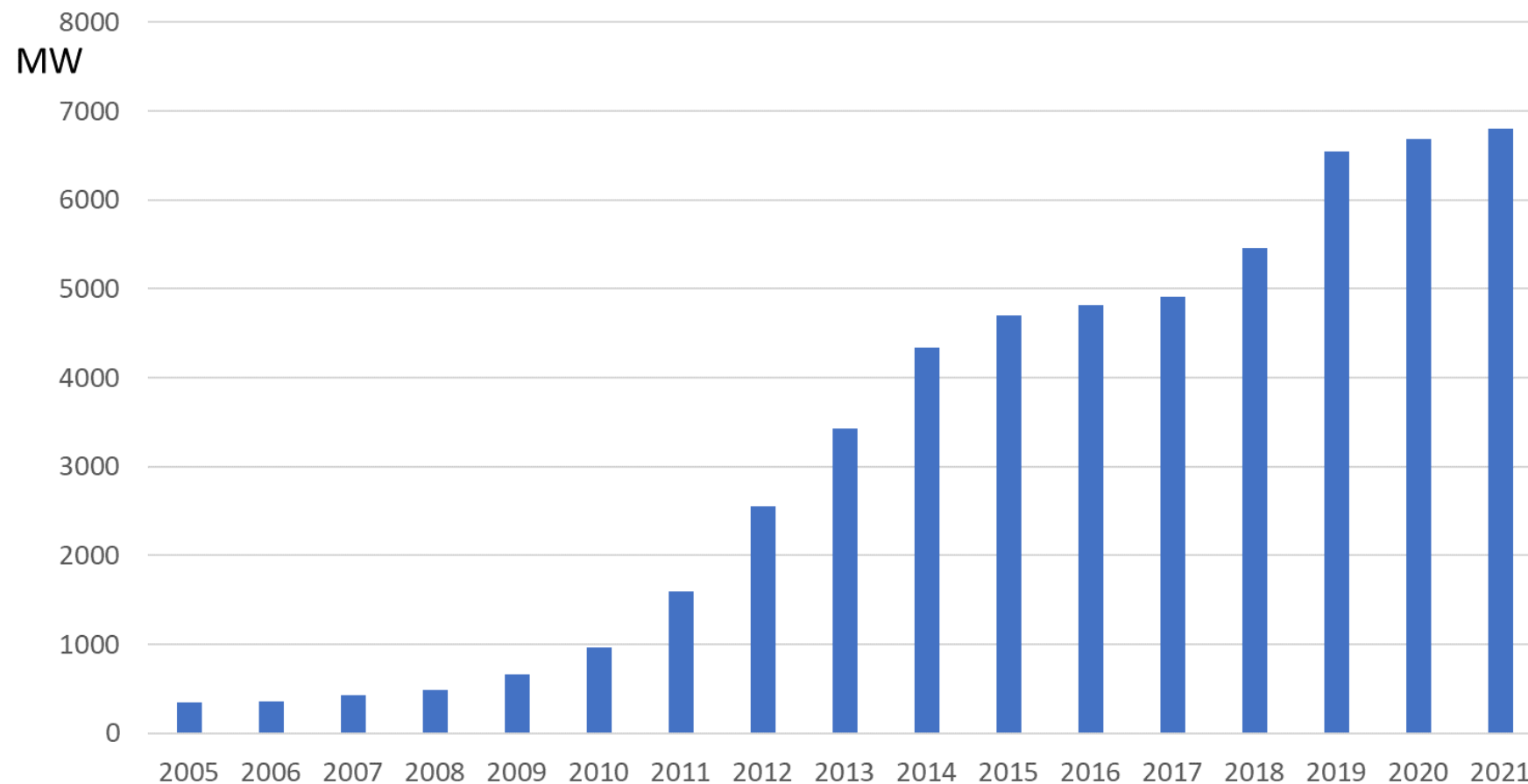



# Vodna energija

# Turbine hidroelektrarn glede na padec in pretok

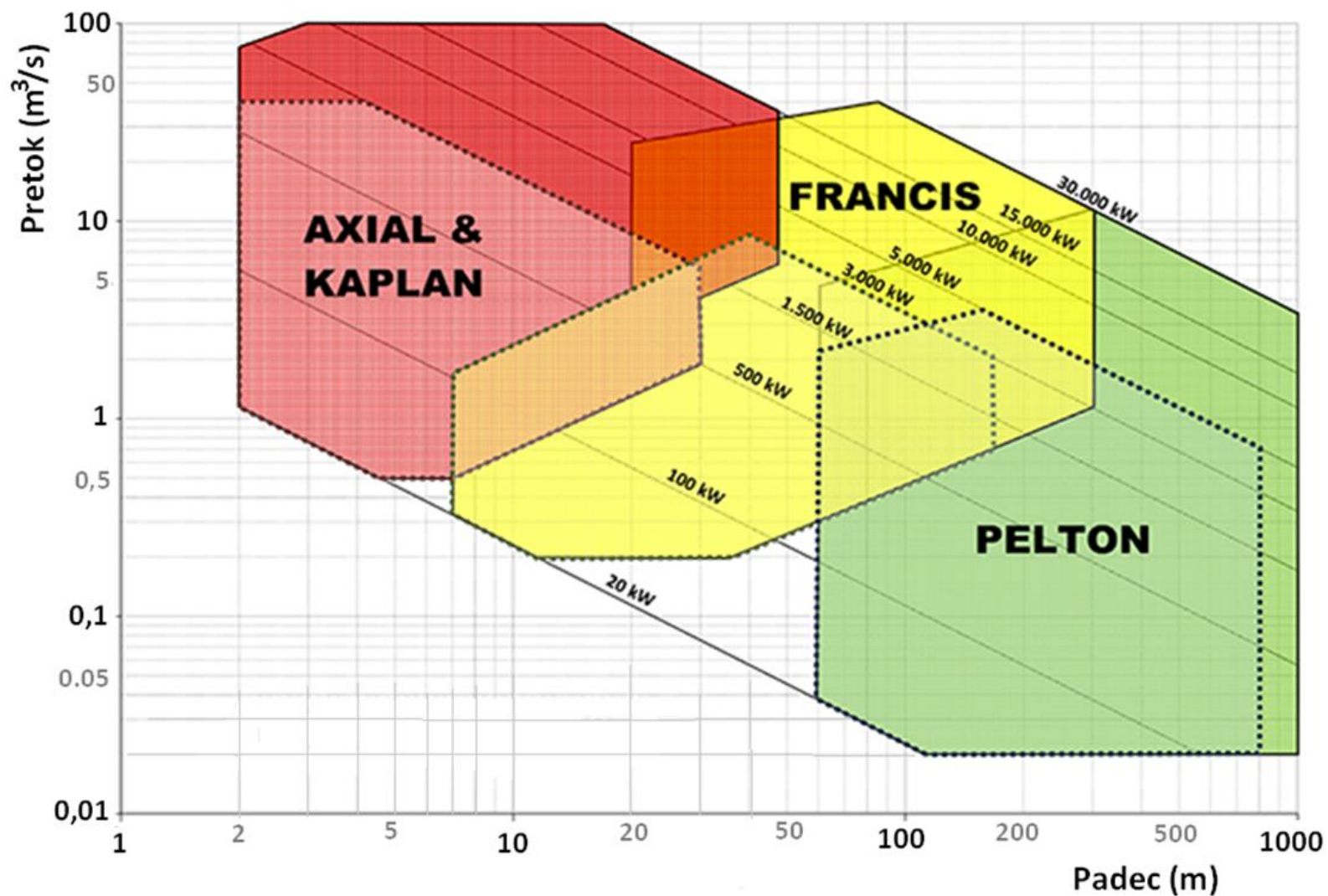



# Pretočna hidroelektrarna

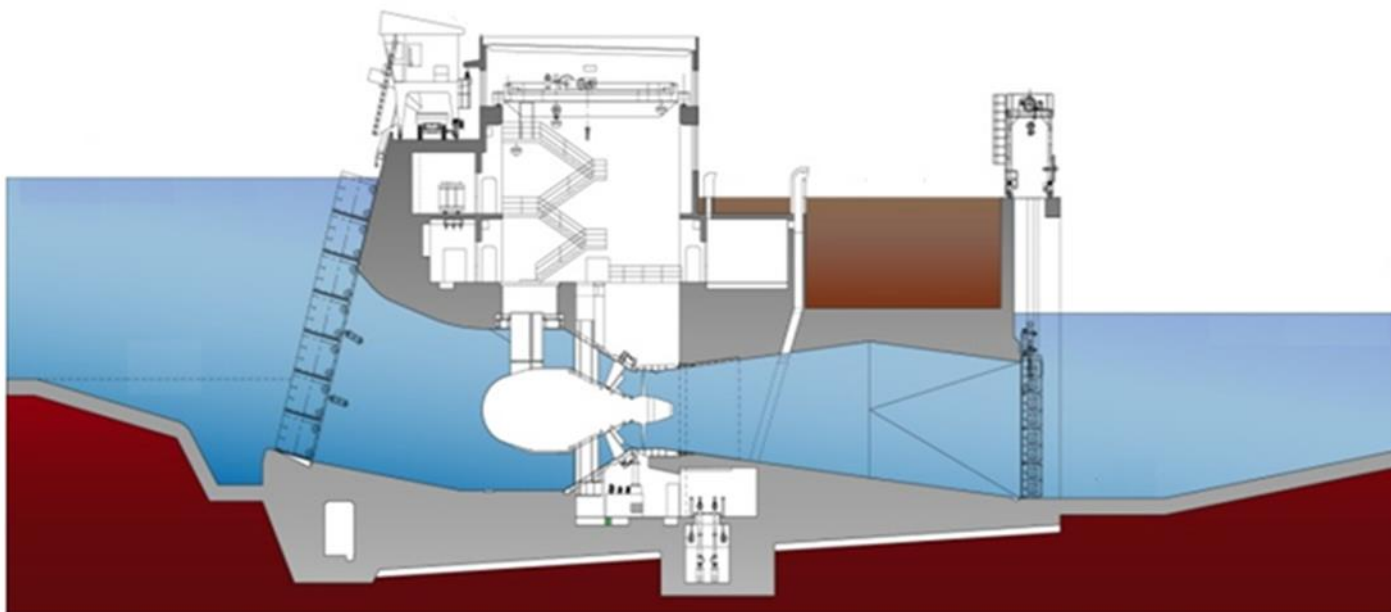

# Akumulacijska hidroelektrarna

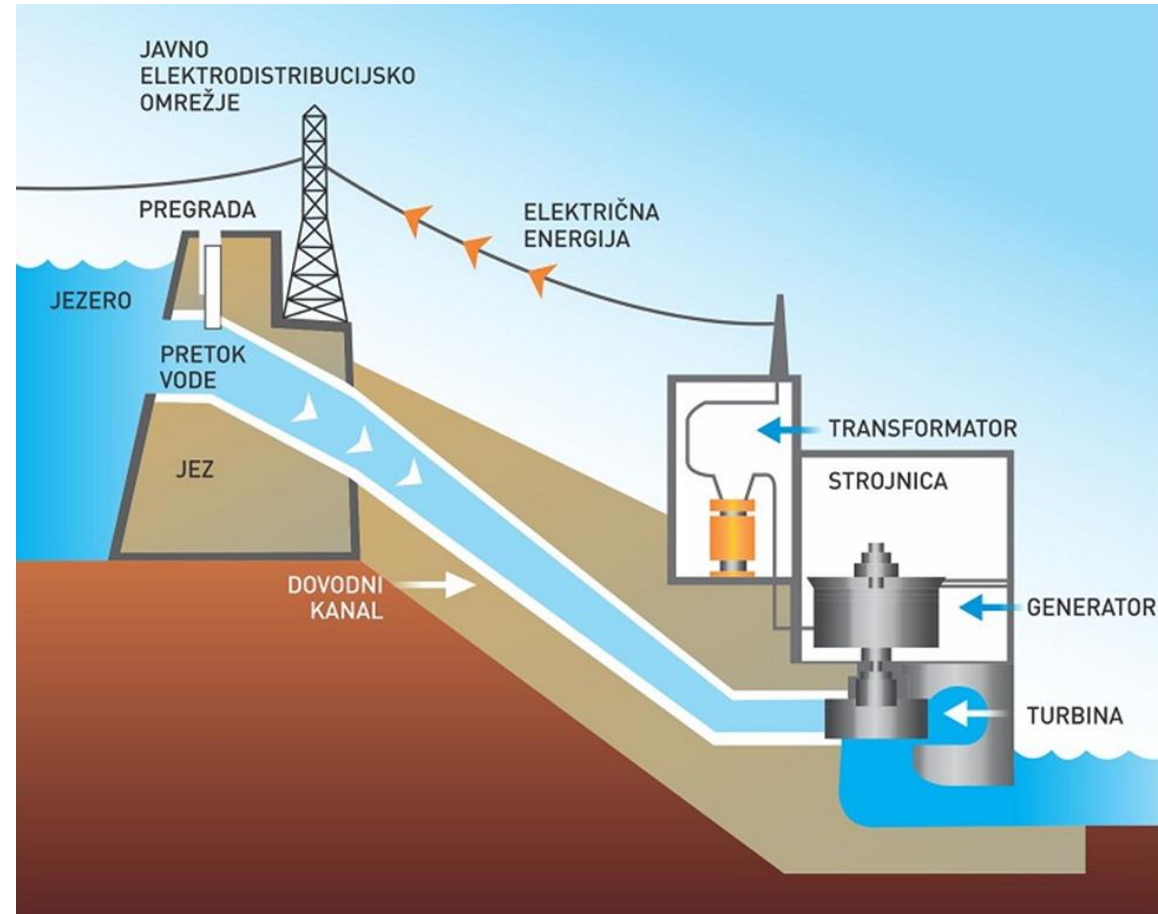

# Črpalno akumulacijska hidroelektrarna



# MHE z arhimedovim vijakom



# Odgovor na omejitve pri posegih v prostor za MHE





# Vetrna energija

# Povprečna letna hitrost vetra 50 m nad tlemi

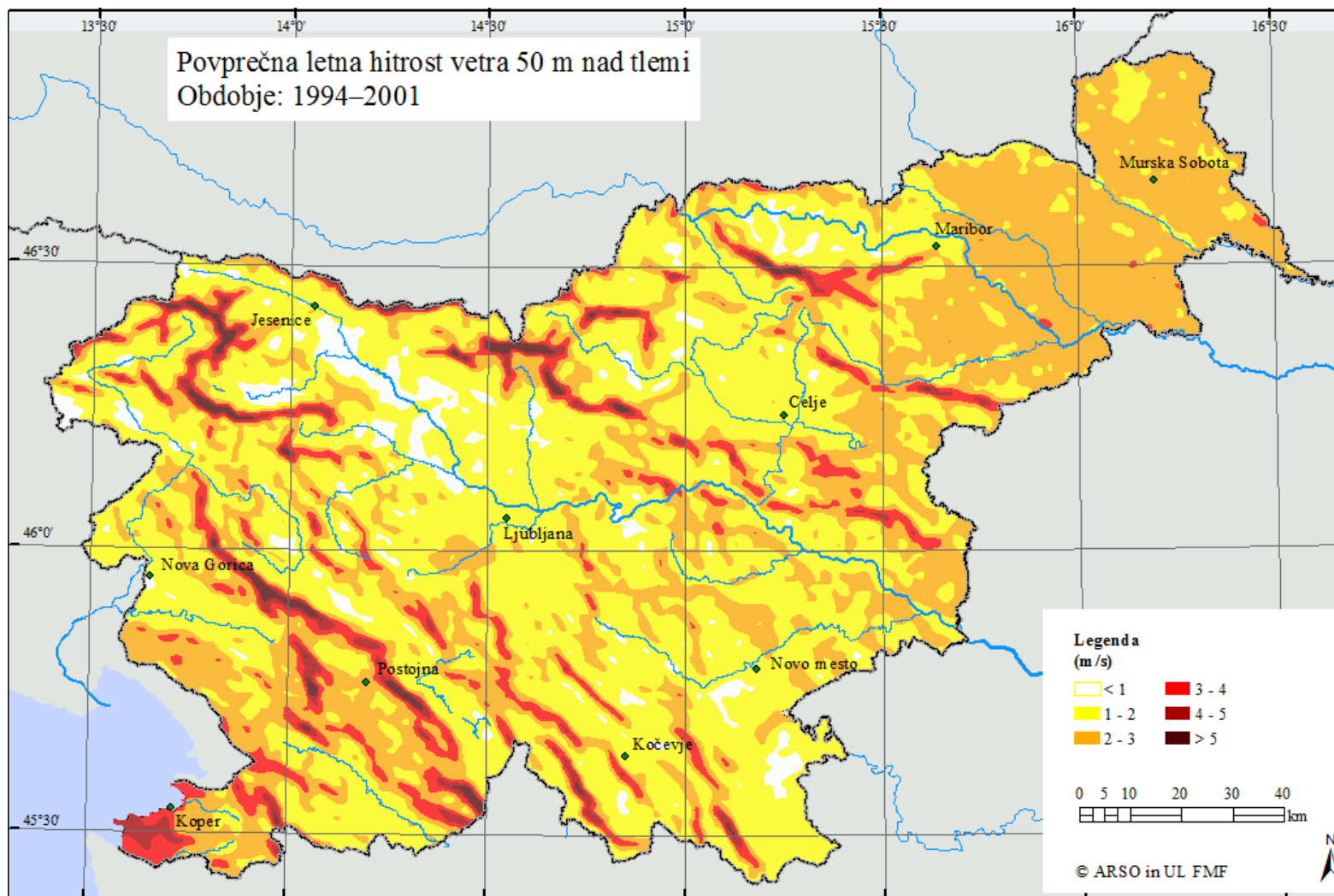

# Odvisnosti moči vetrne turbine od hitrosti vetra

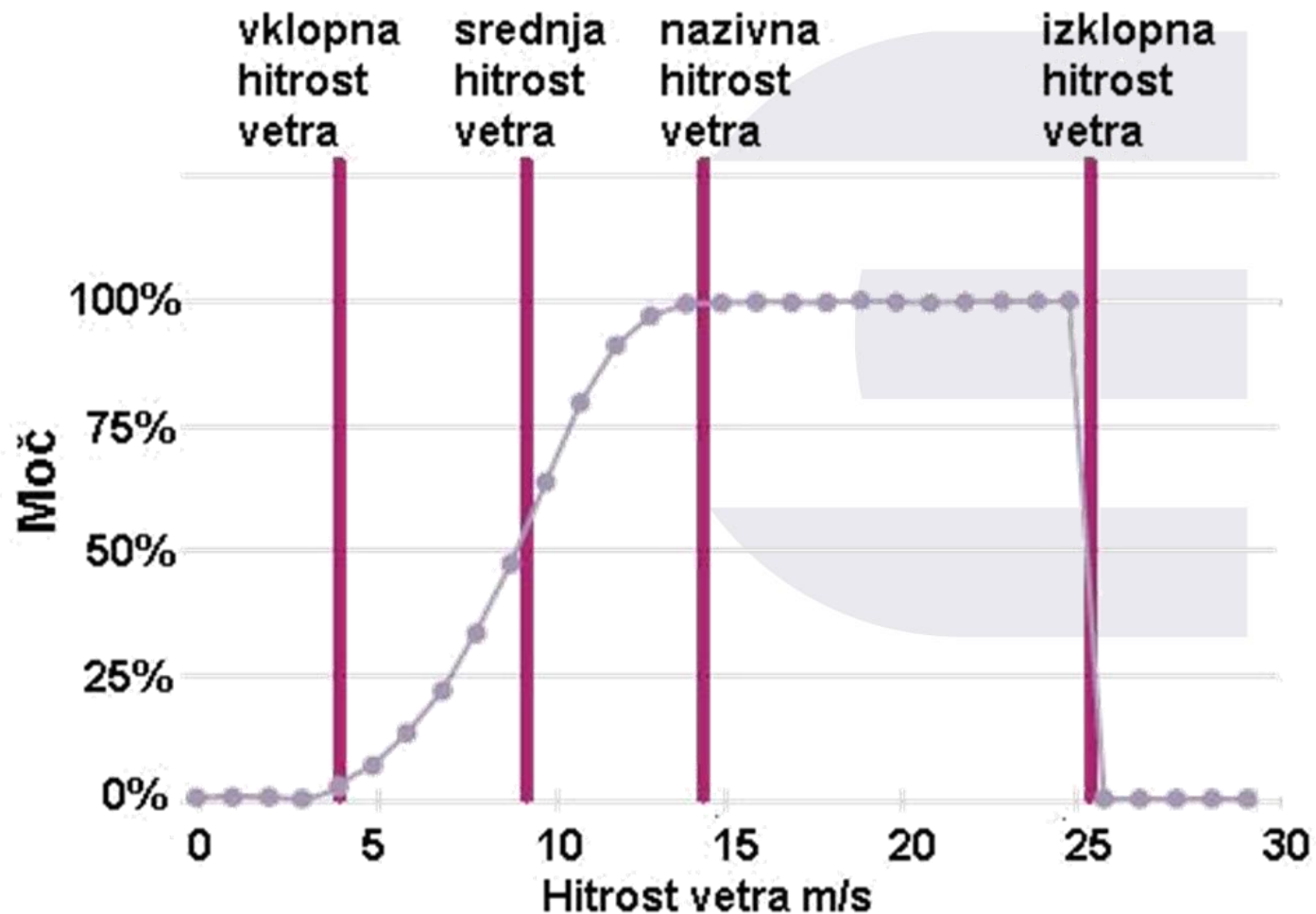



# Razvoj vetrnih elektrarn

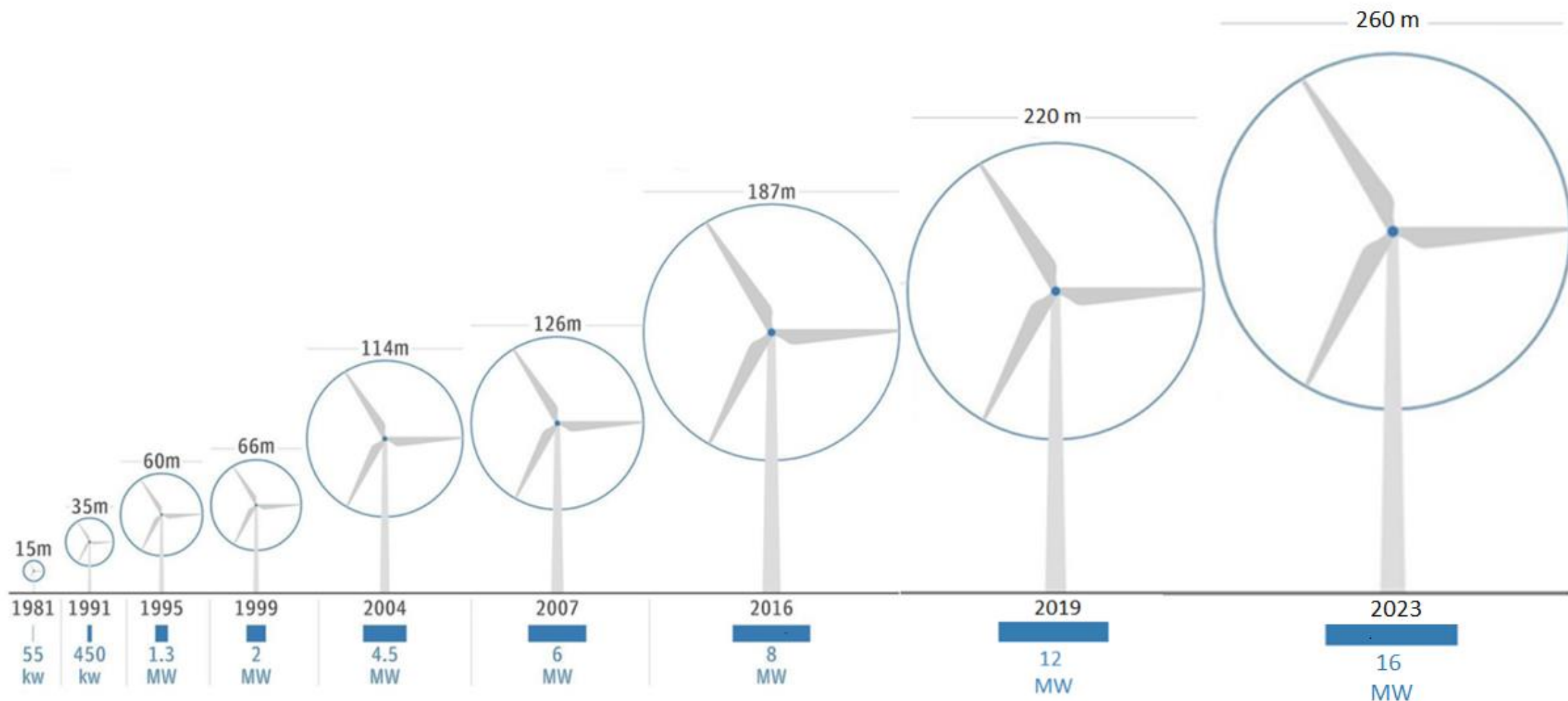

# Vetrna elektrarna

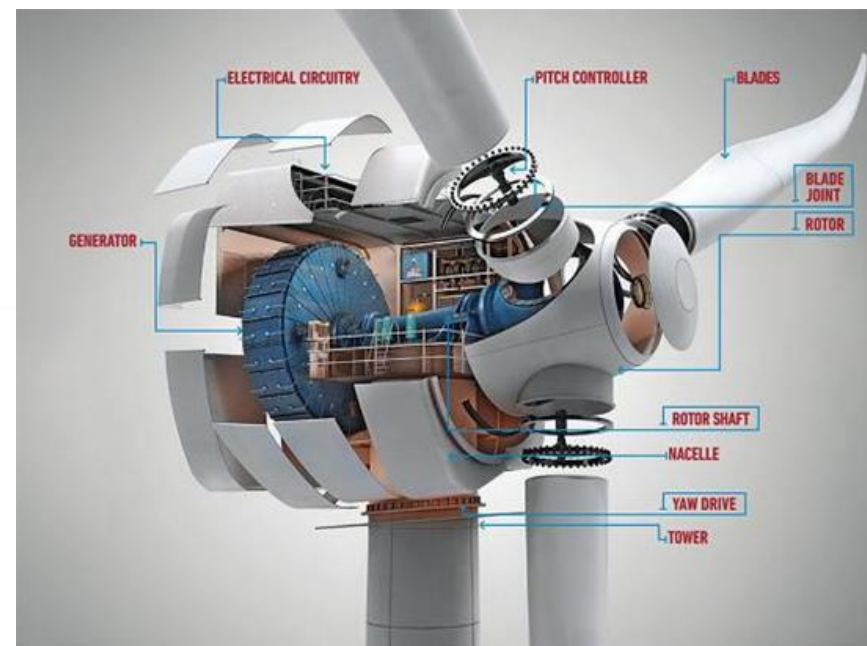

# Svetovna rast vetrnih elektrarn

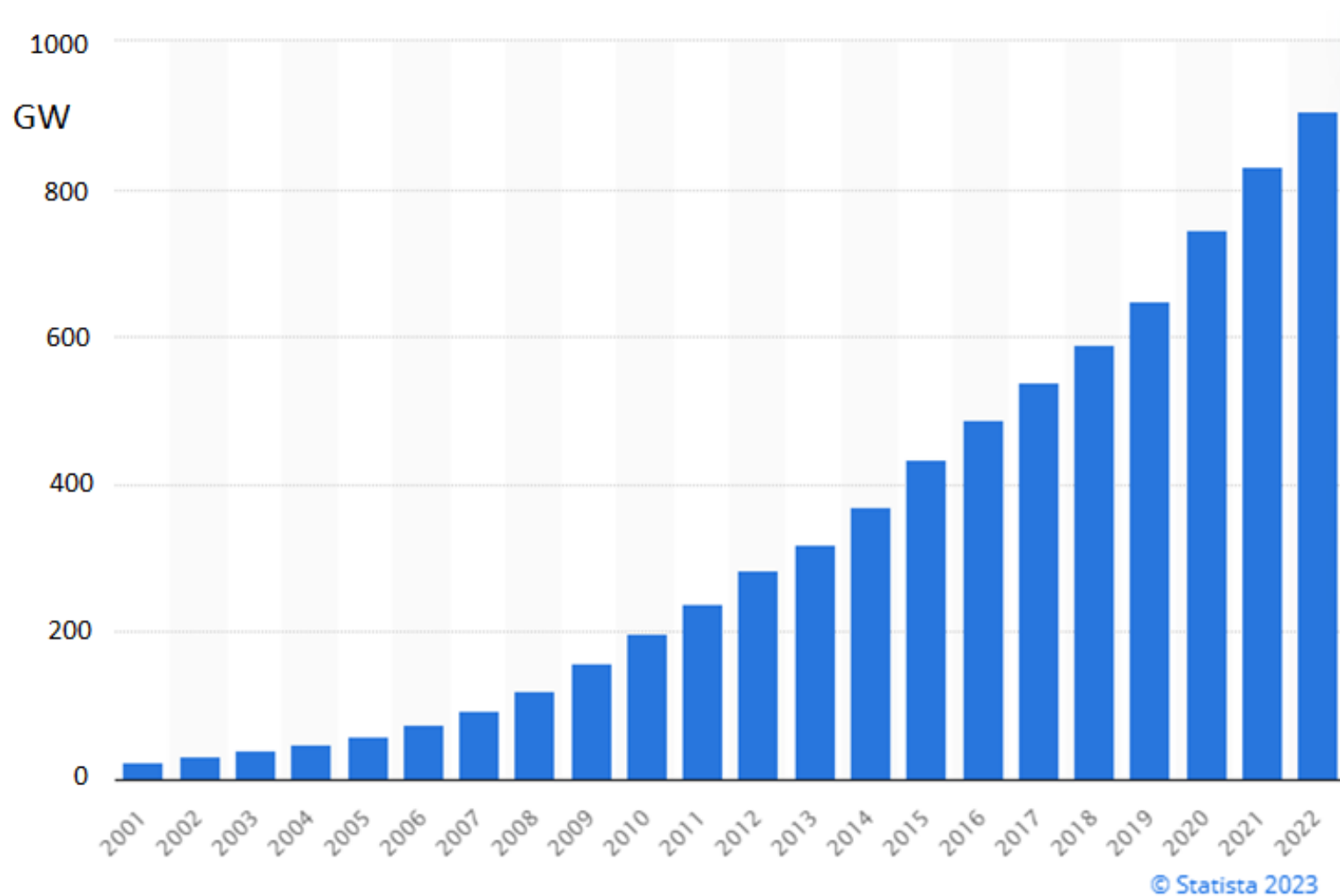



# Energija biomase

# Biomasa kot vir energije

**BIOMASA** - v širokem pomenu označuje vsako organsko snov. Najpogosteje se uporablja za snovi, ki so potencialni viri energije

**BIOMASA (trdno biogorivo)** – v ožjem pomenu predstavlja “biomasa” končno obliko vira energije v trdni obliki

**LESNA BIOMASA**  
briketi, peleti,  
sekanci

**LES**  
polena

**DRUGO**  
Industrijski in  
kmetijski  
ostanki,  
uporabljen les

**BIOGORIVO** – tekoča in  
plinasta goriva, pridobljena iz  
biomase

**BIODIESEL**  
metilni ester

**BIOPLIN,**  
metan

**BIOETANOL**

# Biomasa kot vir toplote

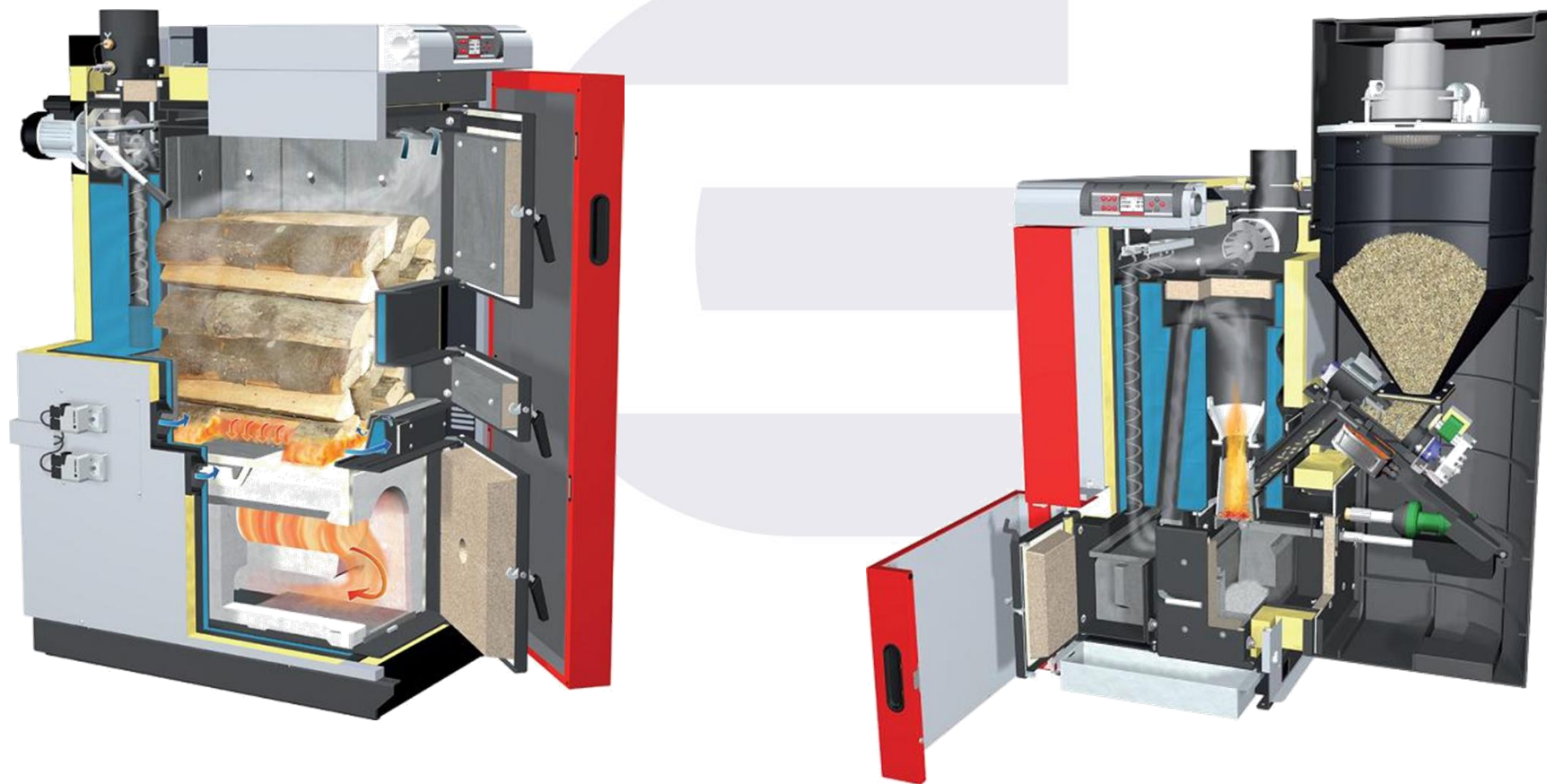

# Toplarna na lesno biomaso z ORC sistemom

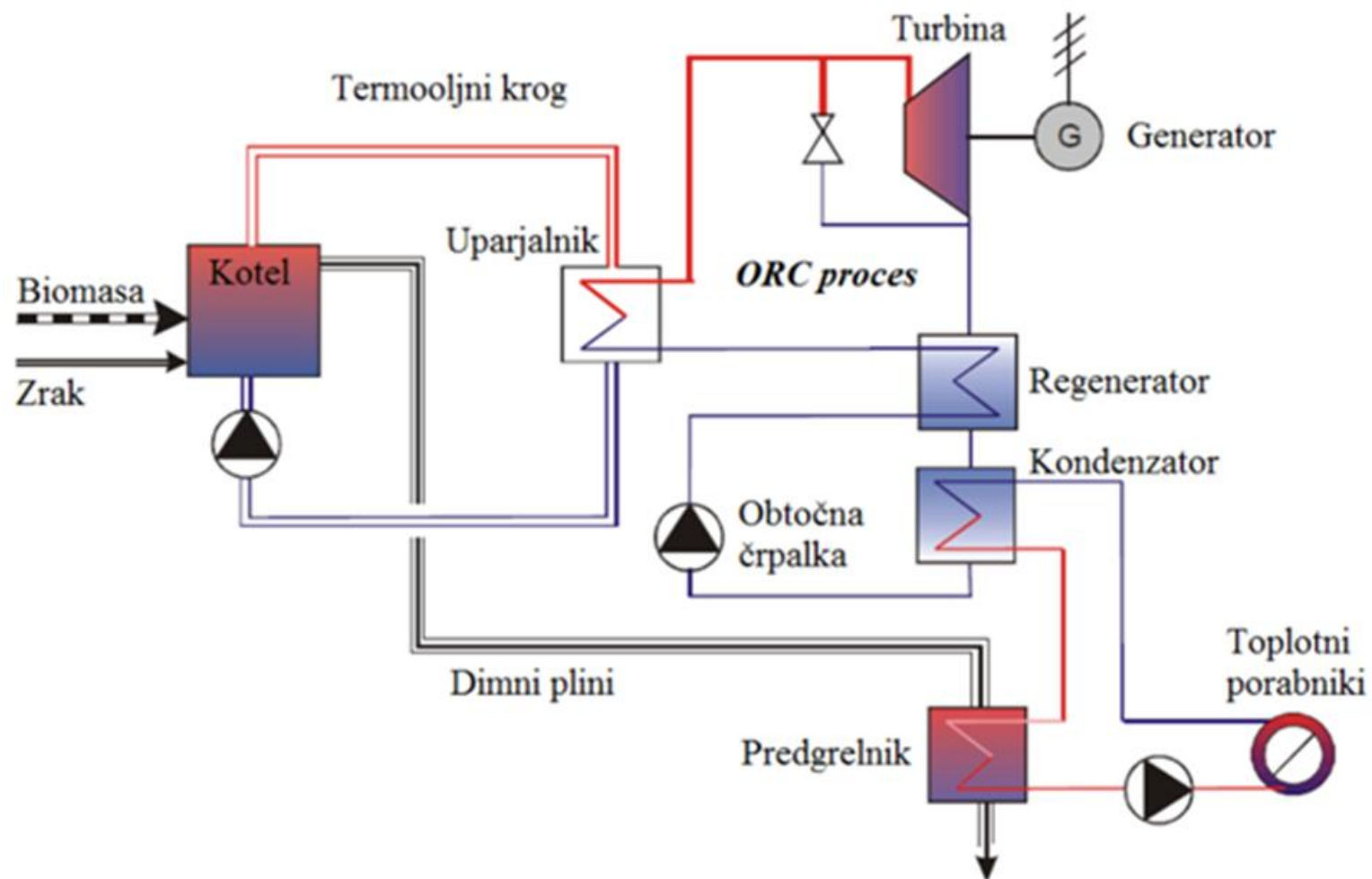

# Bioplinska elektrarna

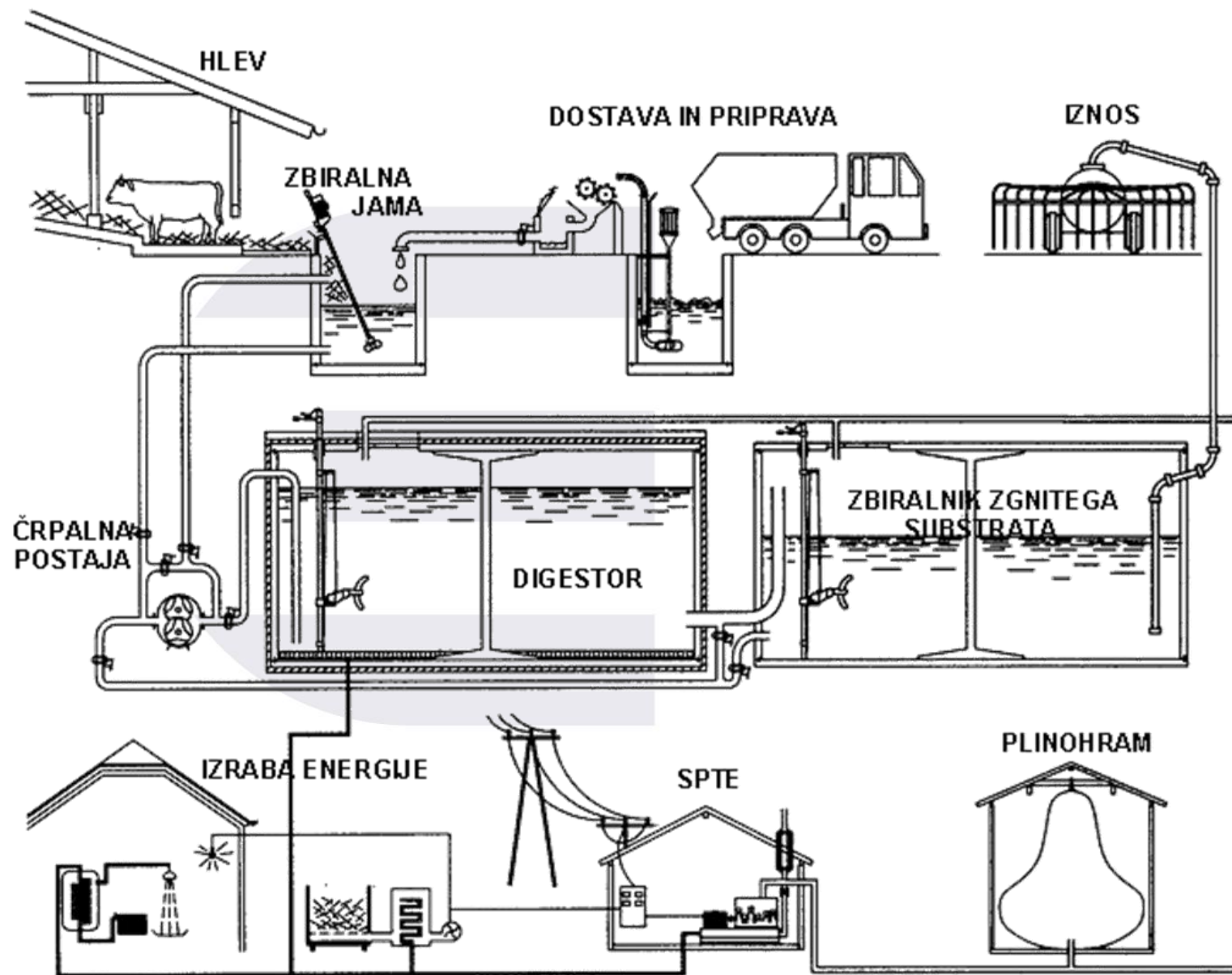





# Energija bibavice

# Elektrarna na plimovanje

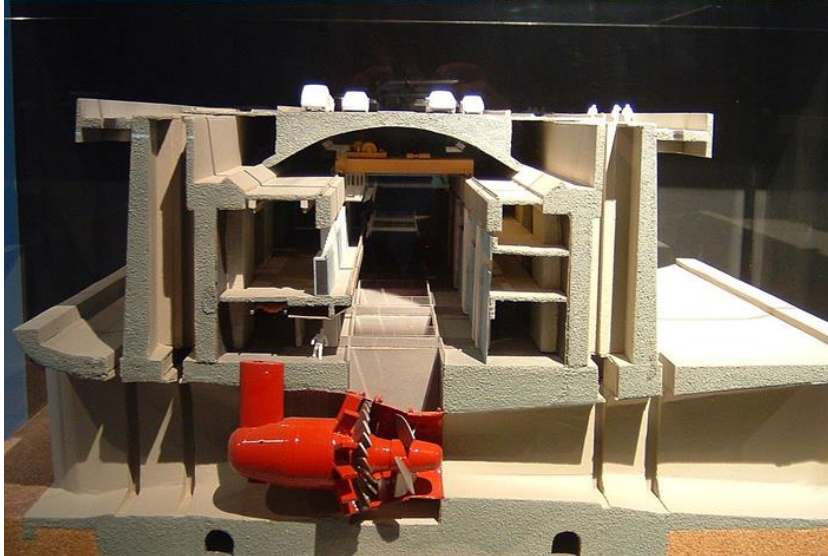

## Elektrarna na plimovanje Rance, Francija

Dolžina jezu	700 m
Amplituda valovanja	8 m
Število turbin	24
Inštalirana moč	240 MW
Capacity factor	28%
Letna proizvodnja	500 GWh
Pričetek obratovanja:	1966



# Geotermalna energija

# Izraba geotermalne energije

Globine (km) izoterme 150°C od površja

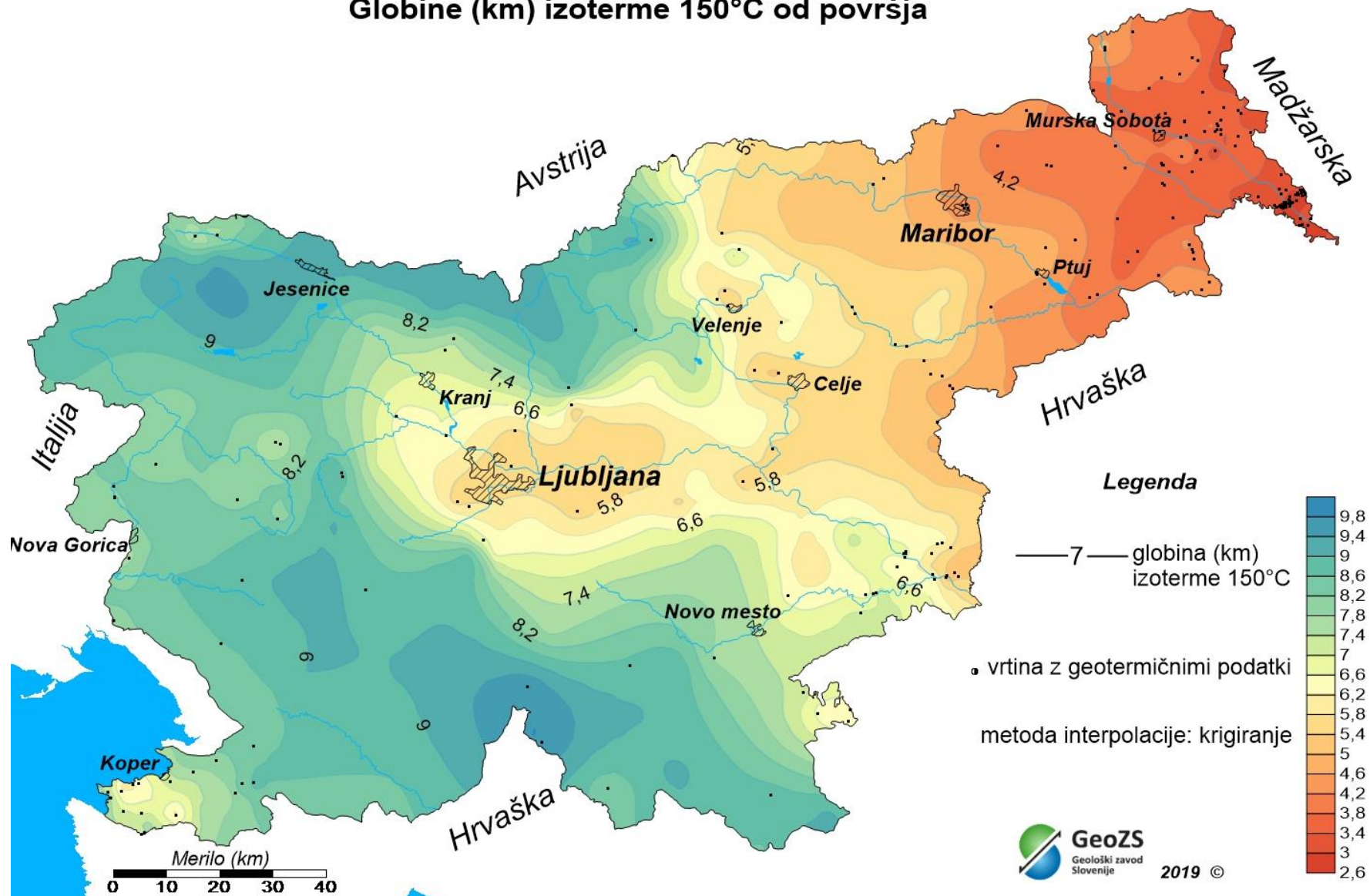

# Proizvodnja elektrike z geotermalno energijo

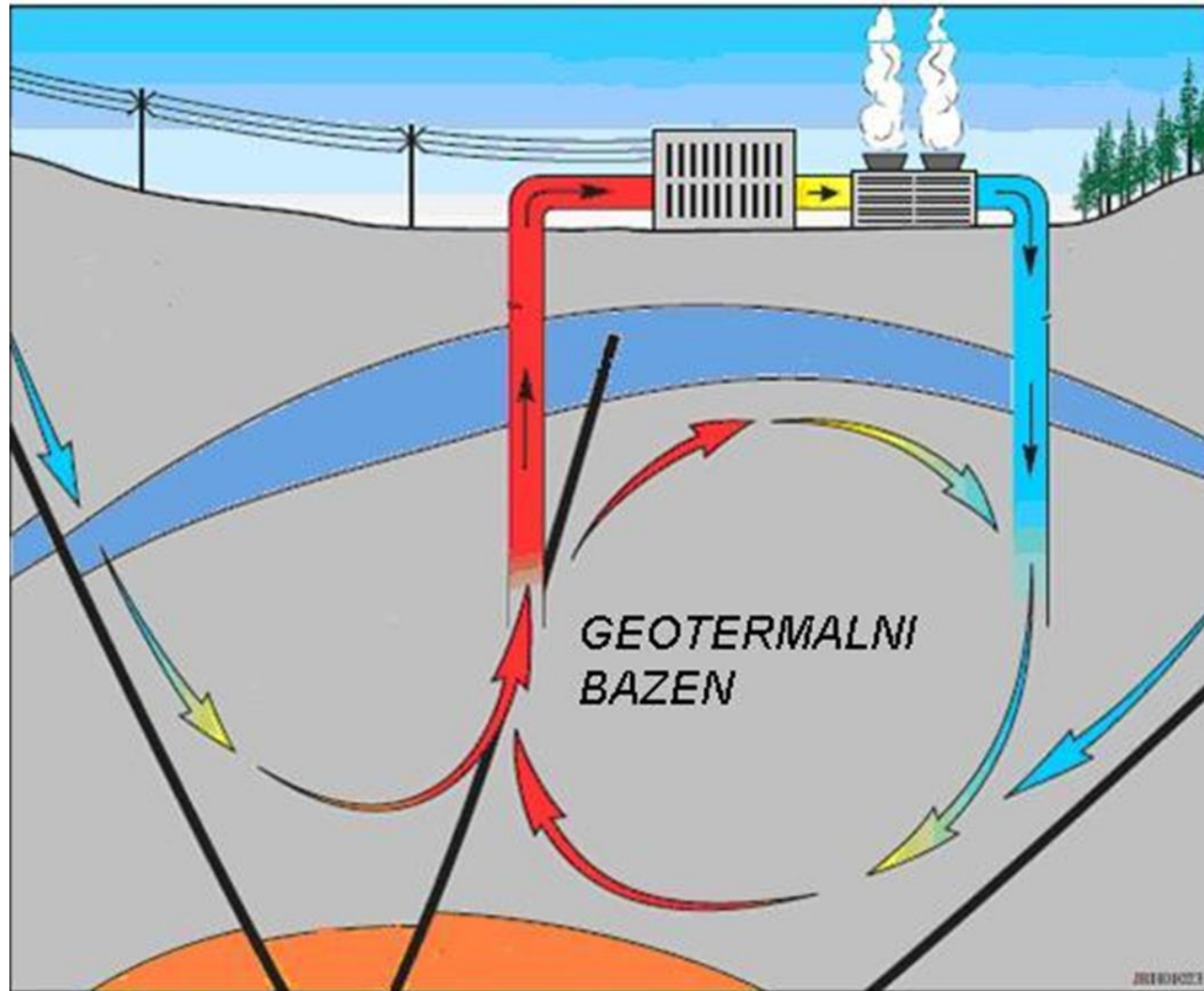

# Proizvodnja elektrike z geotermalno energijo

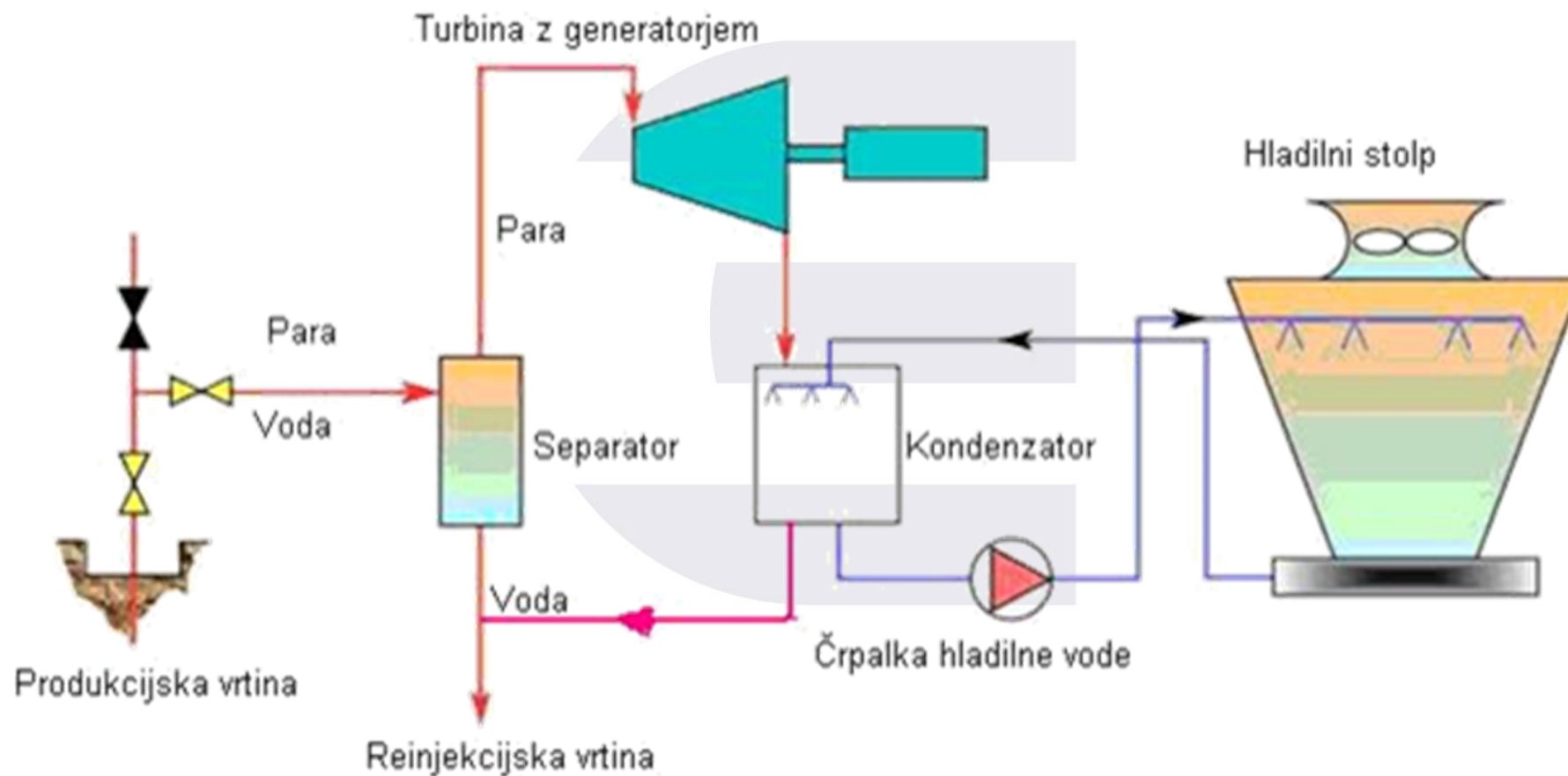

# Proizvodnja elektrike z geotermalno energijo

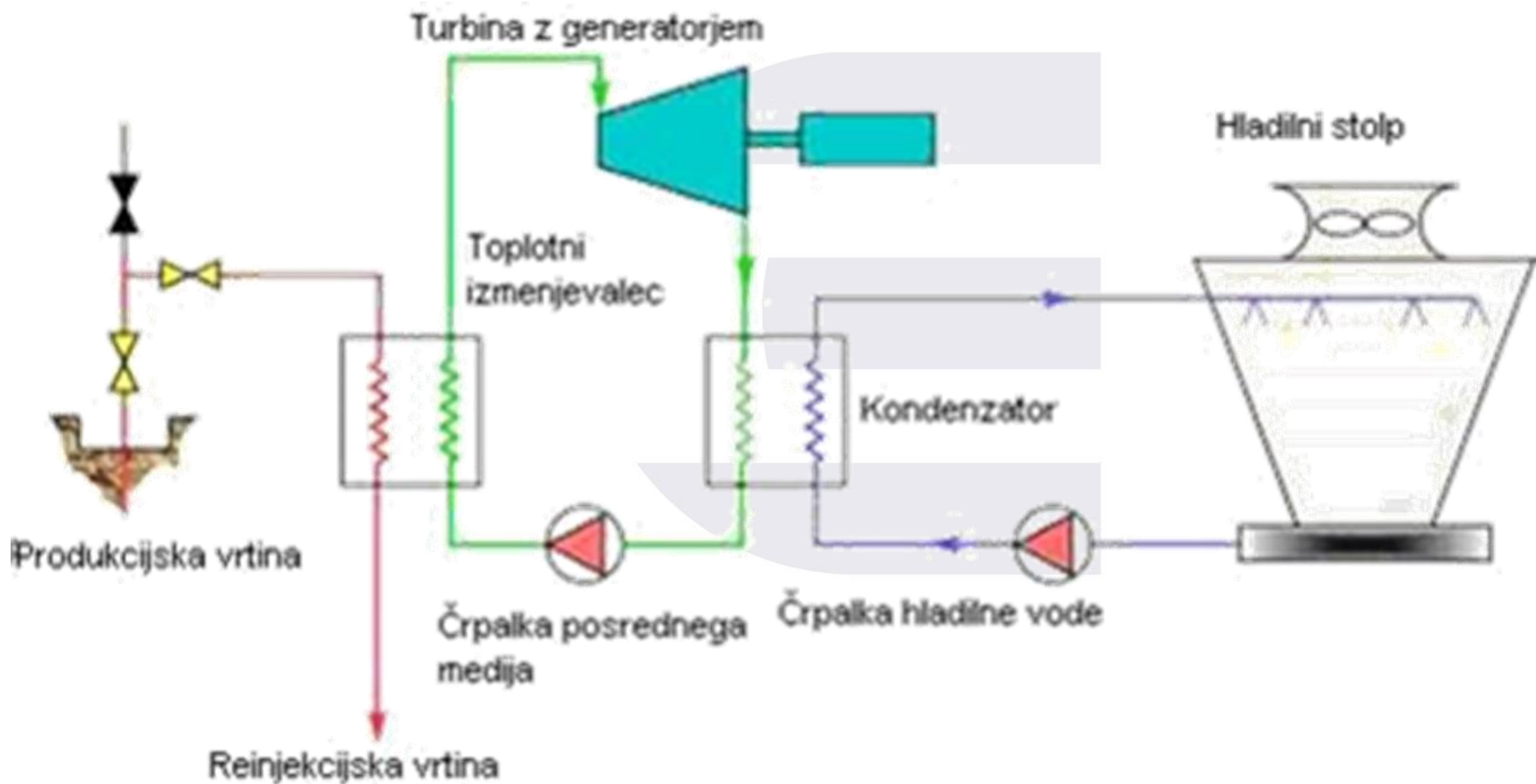



Hvala za vašo pozornost